

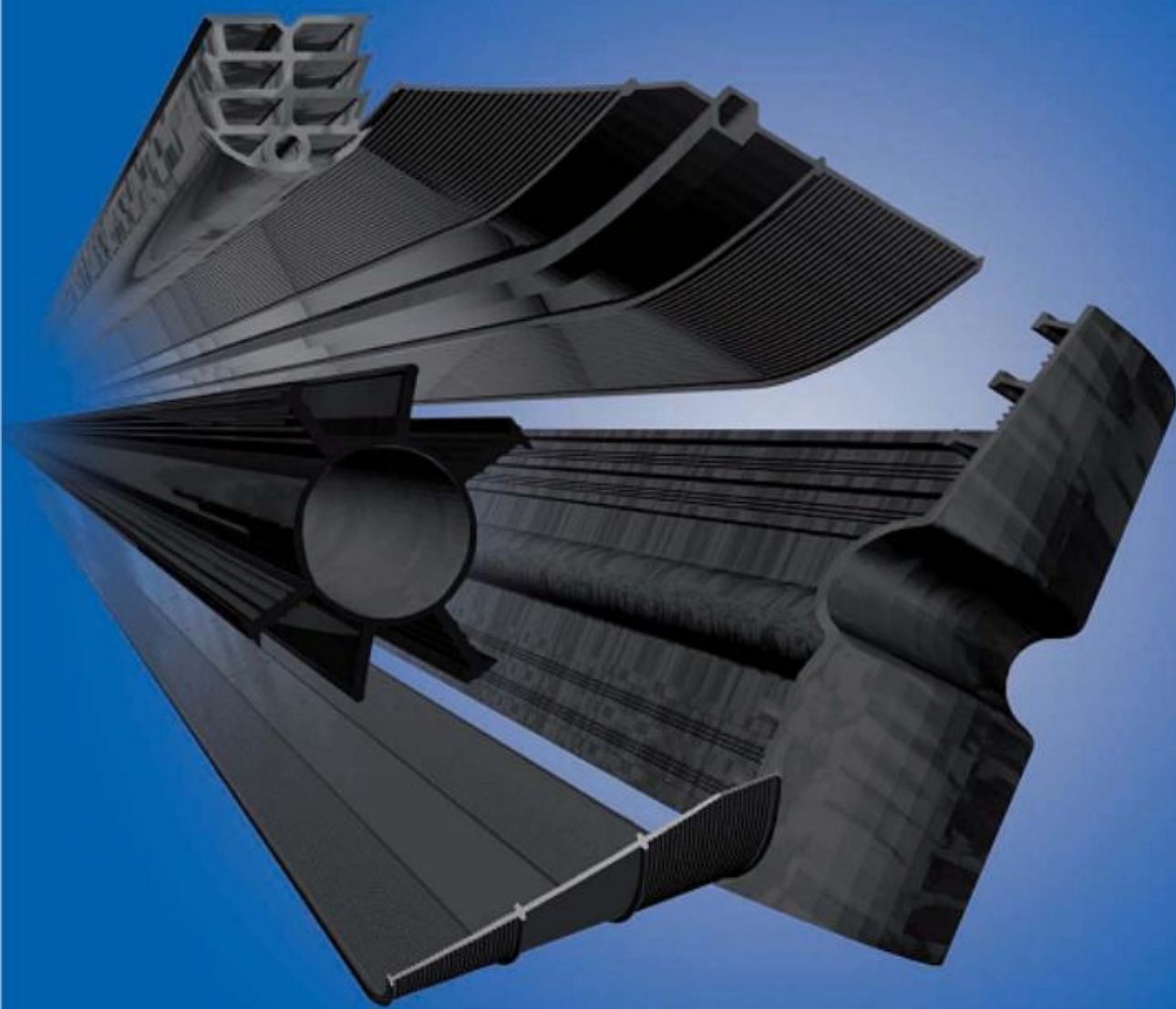

HIDROPLASTO

ANALYZE, PLAN, BUILD



PROFILE HIDROIZOLANTE



Produse speciale pentru Constructii

HIDROPLASTO

WWW.HIDROPLASTO.RO

1. Profilul companiei

2. Planificarea si instalarea

3. Calitatile si tipurile materialelor

4. Profile /benzi etansare

5. Profile cu ancora tip "T"

6. Sisteme / benzi etansare

7. Accesorii profile /benzi etansare

8. Accesorii cofraje

9. Instructiuni de sudura a profilelor



Date privind catalogul

Toate datele continute in acest catalog sunt descrieri ale produselor. Acestea reprezintă informatii generale bazate pe experienta noastră. Nu se vor emite pretentii de despăgubire derivate din aceste date. Daca este necesar, consultati departamentul nostru tehnic. La cerere, vom putea desfășura teste individuale de aplicare pentru caracteristici specifice.

Modificări tehnice

Ne rezervam dreptul de a face modificări tehnice la tiparele profilurilor si schimbări de compozitie la materiale, bazate pe cunoștinte noi.

Instructiuni tehnice

Toate detaliile tehnice nu obliga si nici nu afectează in vreun fel regulile actuale sau vânzările noastre generale si termenii de expediere.

Date privind dimensiunile

Dimensiunile de referinta mentionate in tabele sunt in mm, daca nu sunt specificate altfel.

Schite

Schitele sunt schematici si pot varia de la situatia actuala de instalare.

Drepturi de autor

© 2016: HIDROPLASTO ® ROMANIA

Toate datele rezervate, inclusiv cele de reproducere integrala sau partiala, fotocopiere, traducere sau procesare de date electronice.



Produse speciale pentru Constructii

HIDROPLASTO

WWW.HIDROPLASTO.RO

Puncte de lucru

Botosani – Birouri/Depozit/Productie

Pacea nr.26 , 710011 , Botosani , Romania

Mobil: +40 751 816 727

Tel: +40 231 522 525

Fax: +40 231 522 526

E-mail: office@hidroplasto.ro

vanzari@hidroplasto.ro

hidroplasto@gmail.com

Oradea – Birouri/Depozit/Productie

Str.Uzinelor 80 , 410605, Oradea , Jud. Bihor , Romania

Mobil: +40 770 412 146

Tel: +40 359 170 848

Fax: +40 359 170 857

e-mail: oradea@hidroplasto.ro

hidroplasto@gmail.com



Referinte

PROIECTE SI LUCRARI	PRODUS	BENEFICIAR
Statie epurare loc.Vorona	Profile /benzi etansare A200, D320 Profil /banda etansare KAB 150 Inaltatori crenalati AL30/2 Distantieri rozeta	SC AQUATERM SRL
Statie epurare Brasov	Quellband 10x20 mm Quellband 5x20 mm	SC HIDROCONSTRUCTIA SA
Bazine apa – loc. Calan	Profil / banda etansare A200	SC GEIGER TRANSILVANIA SRL
Statie epurare loc. Falticeni	Profil / banda etansare D 240	CONSIR SA
SEAU – loc. Buftea	Distantieri PlastoPlus Distantieri beton 3H Tub pvc D=22mm, Con pvc D=22mm	SC CORAL SRL
STAP – loc. Vaslui	Quellband 5x20 mm Profile / benzi etansare A240, D240 Distantieri rozeta	SC CORAL SRL
STAP – loc. Miercurea Nirajului	Profile /benzi etansareA200, D320 Distantieri rozeta Distantieri PlastoPlus Distantieri beton 3H	SC CORAL SRL
STAP – loc. Calafat	Profile / benzi etansare A200 Distantieri rozeta Distantieri PlastoPlus Tub pvc D=22mm, Con pvc D=22mm	SC CORAL SRL
SEAU – loc. Pogoanele	Profile / benzi etansare A200, D240 Tub pvc D=22mm, Con pvc D=22mm Distantieri beton 3H	SC CORAL SRL
Statie epurare – loc. Amara	Quellband 5x20 mm Profile / benzi etansare A240, D240	SC CONCIVIC SRL
Statie epurare – Cluj Platforma beton - Cernica	Profil /banda etansare A240	SC ELECTROGRUP SA
Bazine, piscine – Constanta	Profile /benzi etansare A100, A150, A200	SC INGO PISCINE SRL
Statie tratare apa	Profile /benzi etansare A200, D320 Profil /banda etansare KAB 150	SC ABC-CON INTERNATIONAL SRL
Statii tratare apa – loc. Buhusi, Moinesti nord si Moinesti sud	Profile /benzi etansare A200, D320 Profil / banda etansare KAB 150	SC ERBASU EDIL CONSTRUCT SA



Planificarea si instalarea

Informatii generale

Profile/ benzi etansare sunt folosite pentru impermeabilizare /sigilarea rosturilor de structura in constructiile de beton care sunt obligatoriu sa fie impermeabile. Alegerea corecta profilelor / benzi etansare depinde de structura, tipul de rost , mediul in care vor fi supuse si presiunea exercitata asupra acestora :

➤ Tipuri de rost:

Rost de turnare, rost compresie, rost de dilatatie

➤ Miscare:

Miscari de contractie, cicluri de temperatura, incarcaturi dinamice, etc;

➤ Presiunea apei:

Apa cu presiune sau fara

➤ mediu:

chimic, petrolier, coroziv, apa potabila, ape murdare, etc

Selectarea corecta a profilelor de etansare protejeaza substanta din structura in timp si previne cheltuielile de reabilitare ale masurilor de reabilitare de la injectare pentru a finaliza remedierea betonului. In afara de selectarea corecta, un alt factor decisiv este planificarea intregului sistem de pene de etansare ce poate fi instalat de furnizor, dar si de client. Sistemele complexe, sudurile speciale si conexiunile ce trebuie executate, in principiu ar trebui sa fie in sarcina unei societati calificate având o experienta corespunzatoare.

Dimensiuni/ Tolerante

Produsele noastre fac subiectul standardelor privind dimensiunile si tolerantele DIN 18541 și DIN 7865

Planificarea si instalarea

Profile / benzi etansare pentru rosturi de turnare

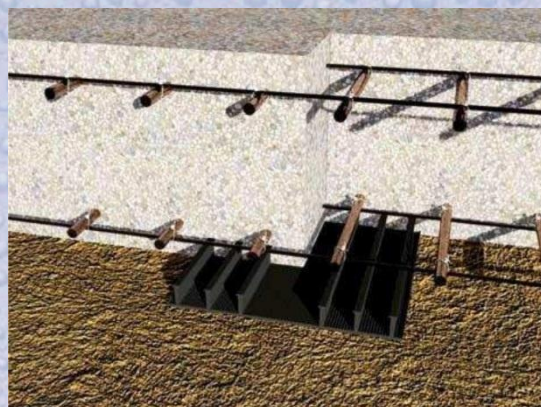
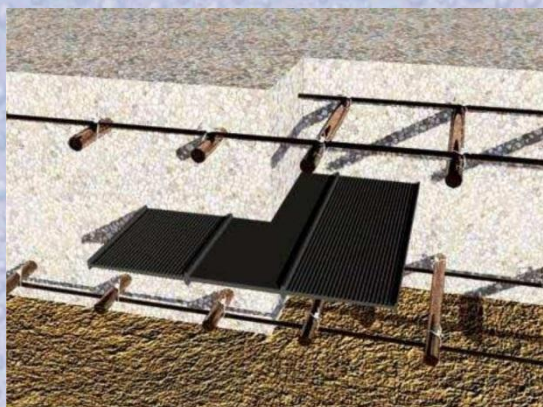

Profile / benzi etansare pentru rosturi de dilatatie

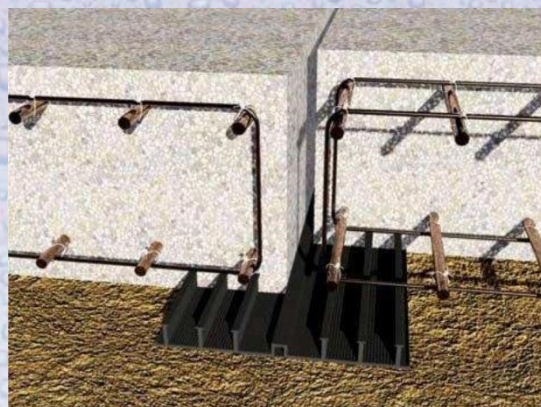
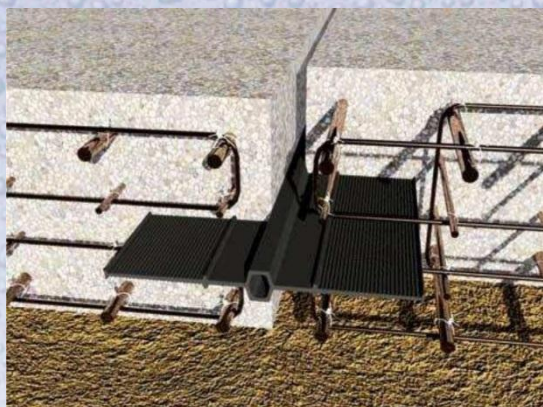

Profile / benzi etansare pentru rosturi de dilatatie acoperite

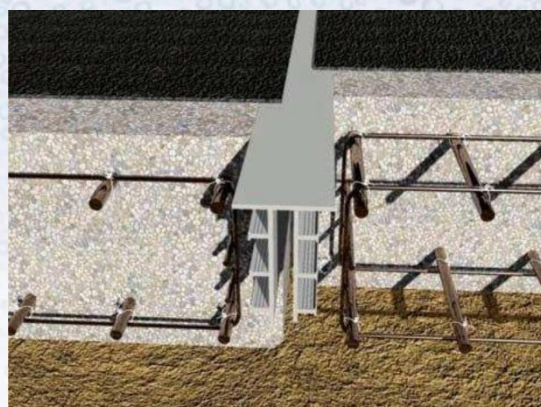
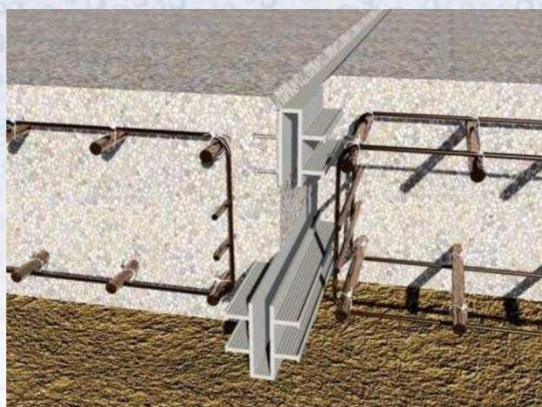

Planificarea si instalarea

Profile de compresie

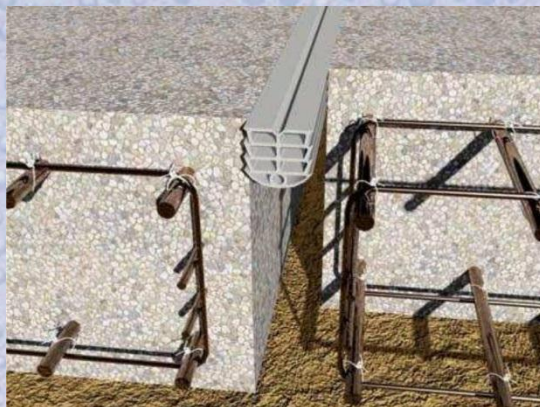
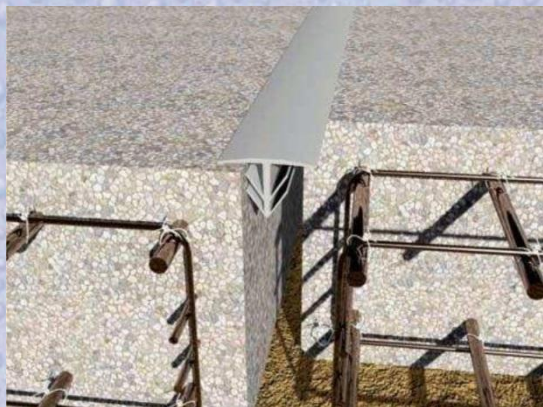

Profile /benzi etansare cu fixare mecanica

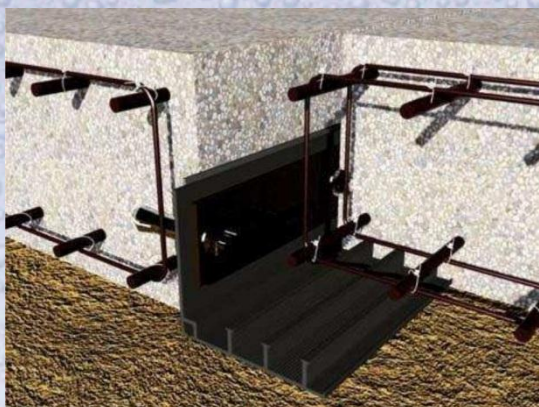

Profile/ benzi etansare pentru crapaturi controlate





Planificarea si instalarea

Profile /benzi etansare

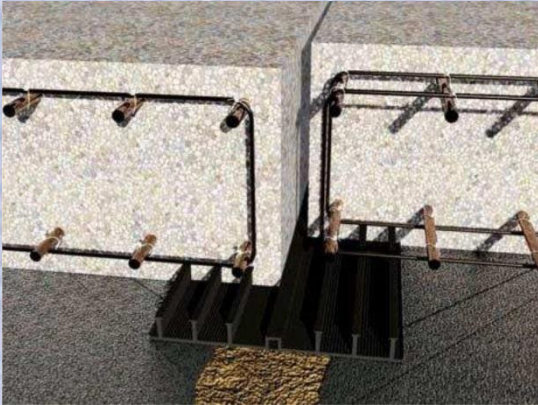

Profile /benzi etansare hidrofiele

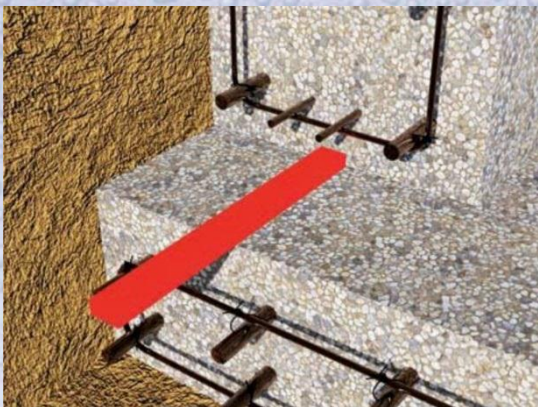

Hidroizolare cu injectie de

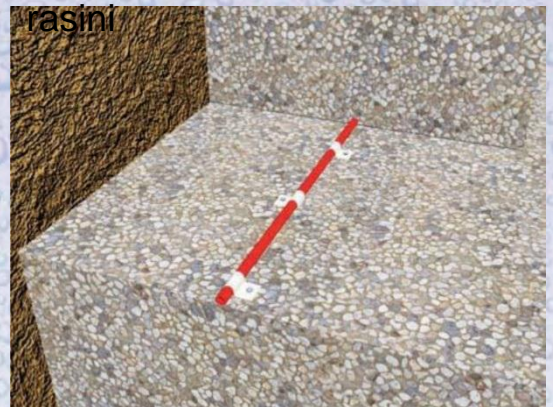

Profile / benzi etansare pentru aplicatii

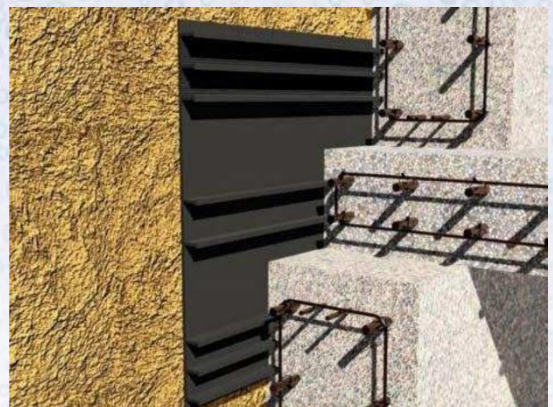
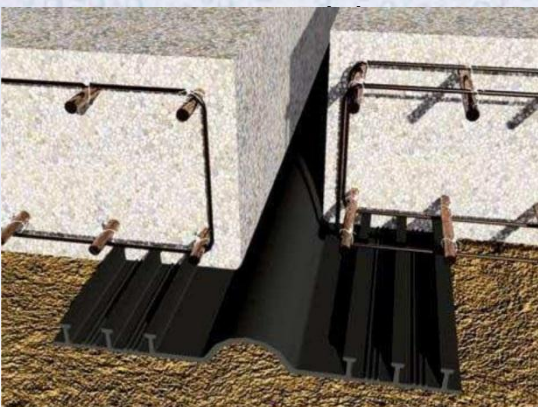



Planificarea si instalarea

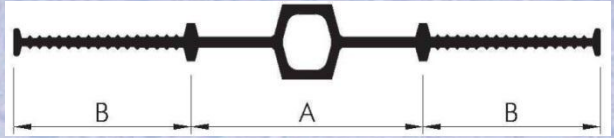

Instructiuni generale

Functionalitatea profilelor / benzi etansare

A = parte extensibila

B = parte etansare

Sistem de etansare

In timpul instalarii, va rugam sa va asigurati ca izolatia sa fie un sistem inchis. De cate ori este posibil, verificati urmatoarele :

- alinierea rosturilor,
- sa nu fie intercalare intre profilele de etansare interne si cele externe.

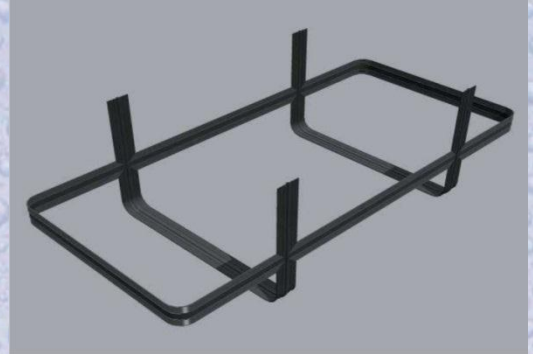

Acoperire beton

Pastrati o distanta de ≥ 20 mm intre profilul / banda etansare si armatura betonului.

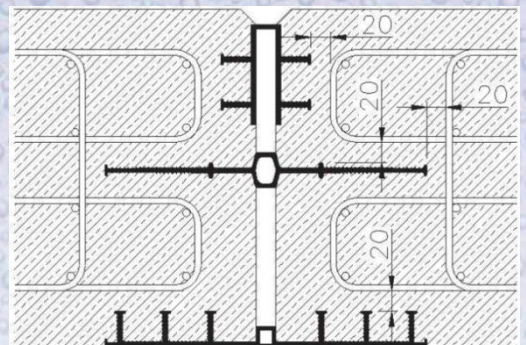

Raza de indoire

Urmatoarele raze de curbura se vor pastra la profilele / benzi etansare:

- profil / banda etansare pentru rosturi de turnare interna: $r \geq 150$ mm
- profile profil / benzi etansare pentru rosturi de dilatatie interne: $r \geq 250$ mm
- profile / benzi etansare pentru rost de turnare externe: $r \geq 50 \times$ mm
- profile / benzi de etansare rosturi de dilatatie externe: $r \geq 30 \times$ mm

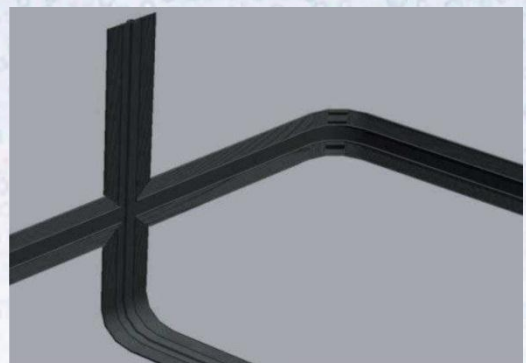



Planificarea si instalarea

URMATOARELE INFORMATII SUNT VALABILE DOAR PENTRU SITUATIILE STANDARD!

Explicatie

- Aceste valori sunt valabile pentru rosturile de turnare cat si pentru rosturile de dilatatie.
- Latimea profilelor/ benzii etansare interne nu trebuie sa depaseasca grosimea elementelor structurale.
- Latimea constructiva a rosturilor W-nom:
 - Profile /benzii etansare externe: 20 mm
 - profile /benzii etansare intrene: 20 - 30 mm
 - Profile /benzii etansare pentru rosturi de dilatatie acoperite :20-30 mm

Dimensionare

Calcularea miscarilor existente:

$$v_R = v(\sqrt{v_x^2 + v_y^2 + v_z^2})$$

Deformare permisa totala:

- vezi diagramele pentru dimensionare, (depinde de presiunea apei)
- Conditii de limitare:

$$v_x: w\text{-nom} = 20\text{mm}: w_{\min} \geq 15\text{mm}$$

$$w\text{-nom} = 30\text{mm}: w_{\min} \geq 20\text{mm}$$

$$v_y \leq w_{\text{nom}}$$

$$v_z \leq w_{\text{nom}}$$

v = deformare

w = latimea rostului

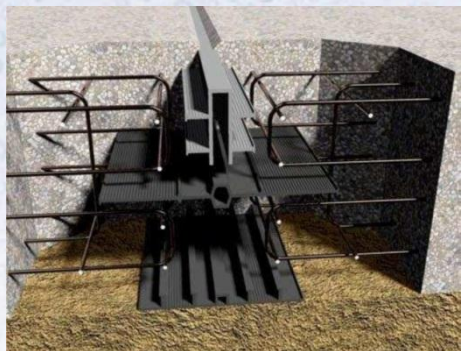



Planificarea si instalarea

Besaflex seria D (standard companie)

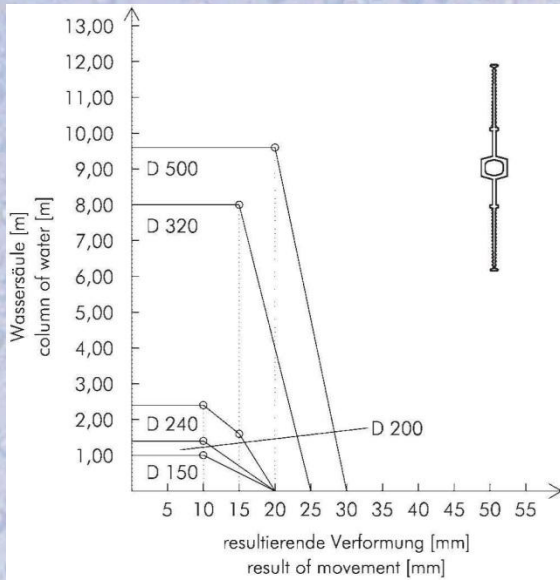

Nitriflex seria D (DIN 18541)

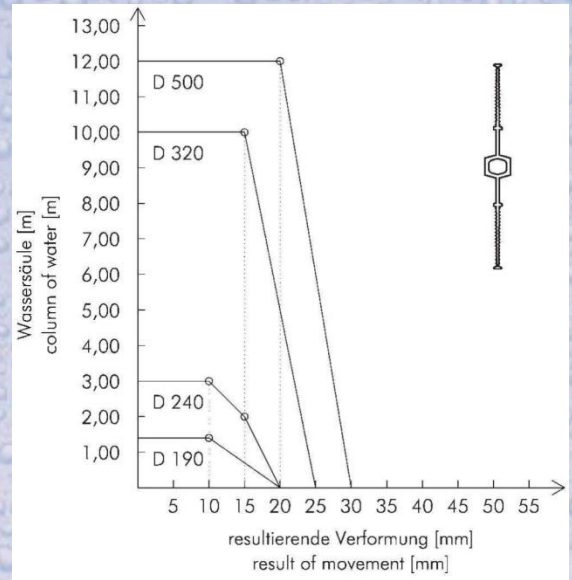

Elastoflex seria FN (DIN 7865)

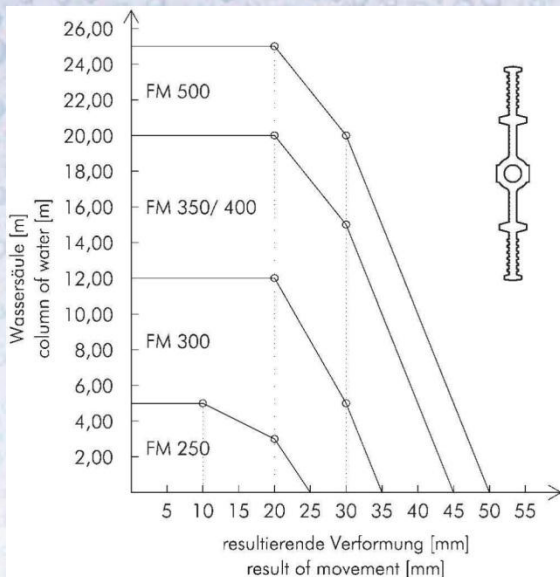

Elastoflex seria FNS (DIN 7865)

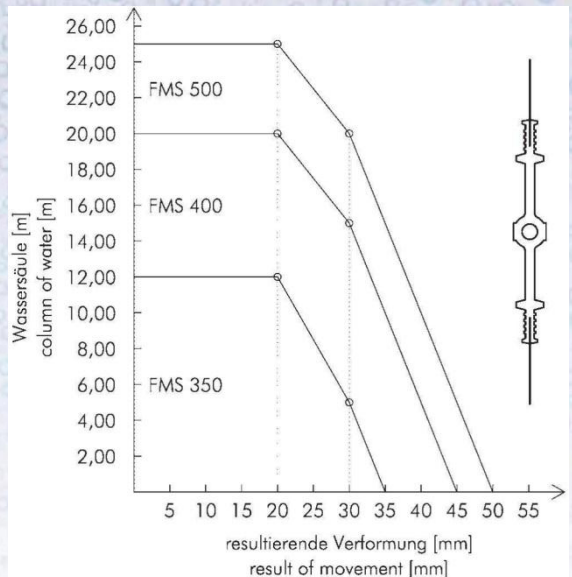



Planificarea si instalarea

Besaflex seria AD standard companie Besaflex seria AD standard companie

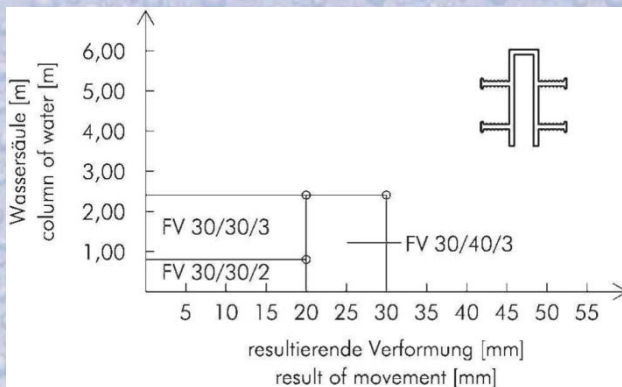
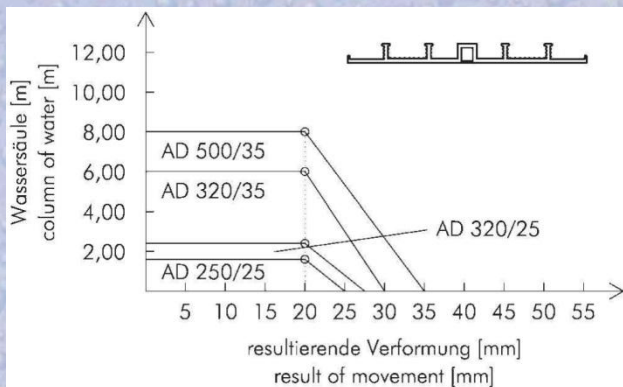

Nitriflex seria DA (DIN 18541)

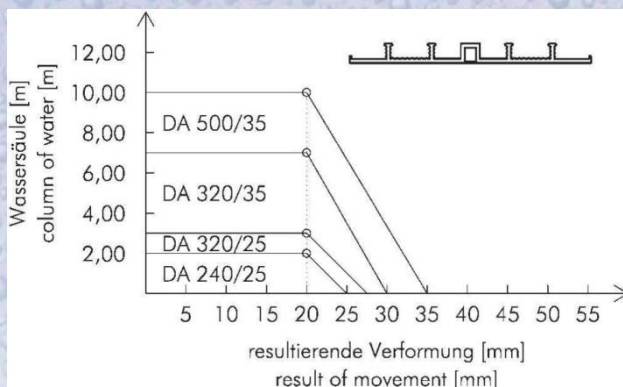

Nitriflex seria FA (DIN 18541)

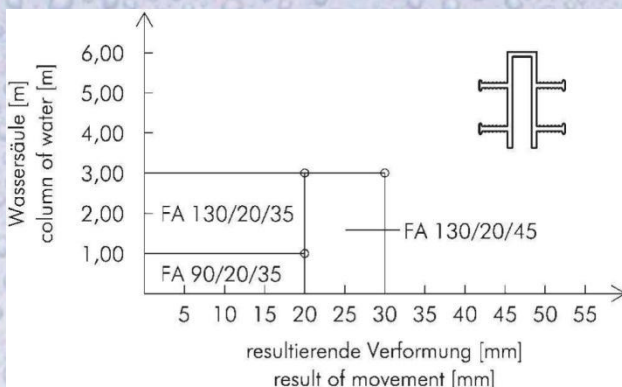

Elastoflex seria AM (DIN 7865)

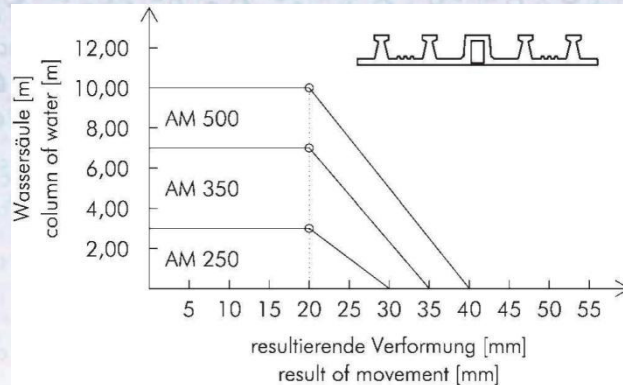

Elastoflex seria FAE (DIN 7865)

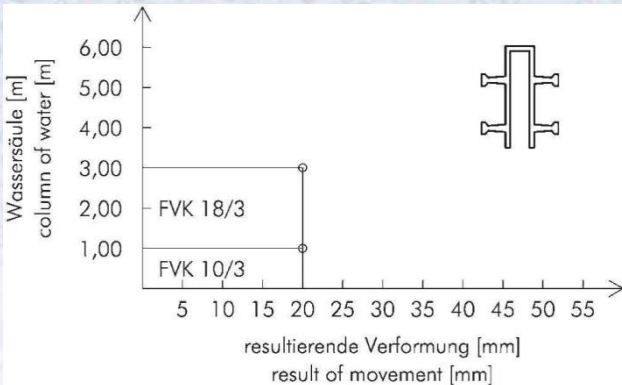



Planificarea si instalarea

In momentul instalarii profilelor se va verifica linearitatea acestora

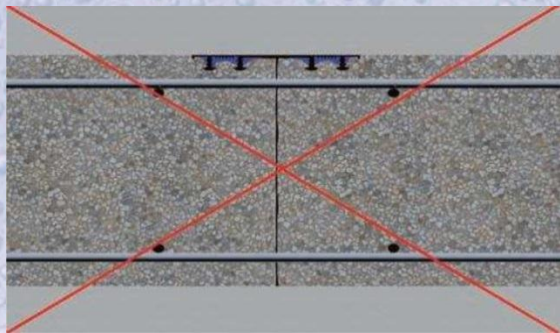

Nu se vor instala niciodata profilele / benzi etansare externe cu ancorele de fixare orientate in jos! Acest lucru ar putea duce la retasuri si posibile infiltratii.

Deformarile usoare (cauzate de conditiile de depozitare sau de transport) pot fi corectate prin tratare la caldura. Penele de etansare termoplastice sunt fuzibile la cca. 140 °C!

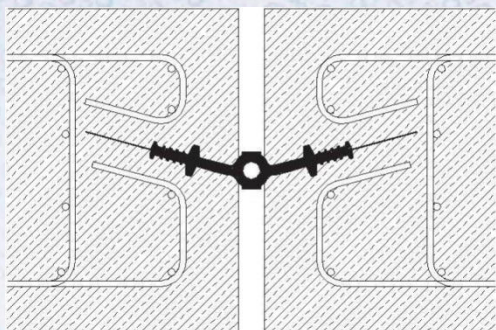

Pentru o turnare a betonului corecta fara segregari si retasuri in zona profilului / benzi etansare de dilatatie, se recomanda pozitionarea acestuia in forma de "V" la un unghi de aproximativ 15 °



Planificarea si instalarea

Fixarea

Fixarea dispozitivelor depinde de de tipul acestora:

- Profilele /benzi etansare interne: cleme de montaj, cuie, armatura speciala, sarma
- Profilele /benzi etansare externe: cleme de montaj, cuie, armatura speciala, sarma



In momentul instalarii se va tine cont de linearitatea profilului, simetria acestuia fata de axa rostului, sistemul de prindere va fi echidistant

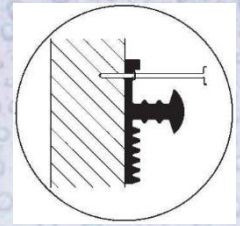
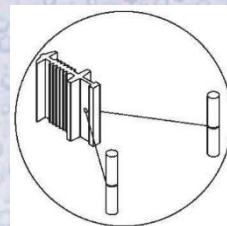

Capetele ramase ale profilului se vor proteja in vederea sudurii sau vulcanizarii ulterioare





Planificarea si instalarea

Conexiuni/suduri

Pe santier se pot executa doar suduri de baza , cele complexe se vor face la furnizor

Sudurile profilelor / benzi etansare se face doar de catre o persoana calificata, instruita in prealabil de furnizor

Temperatura mediului de lucru sa nu fie sub 0 grade

Materiale termofuzibile:

- Besaflex
- Nitriflex
- Polyflex
- TPE

Materiale nonfuzibile (se vulcanizeaza)

- Elastoflex

Lungimea capetelor ce trebuie pastrate:

- Lungimea in vederea sudurii 50 cm
- Lungimea formatelor din fabrica 50 cm
- Lungimea capetelor profilelor in cazul sectiunilor de beton diferite 100cm



Proprietatile materialelor

Prezentare generala

- PVC usor cu AbP1),Besaflex®:
- Duritate: scazuta pana la normal.

Nitriflex®:- PVC/ NBR conform DIN 18541,

- Duritate: ridicata,
- rezistenta chimica inalta.

Elastoflex®:- Elastomer conform DIN 7865,

- Duritate: ridicata,
- grad ridicat de elasticitate .

Besaflex®BS

- PVC usor conform standardelor companiei,
- Indeplineste standardele din Marea Britanie (BS).

Polyflex:- Polietilena conform standardelor companiei,

- potrivit pentru conexiunile cu acoperiri etansare plastic din PE

TPE:- Elastomer termoplastic,

- similar cu Elastoflex, dar se poate suda

1) AbP =certificare testare de la Inspectoratul general de constructie

Besaflex conform standardelor companiei

Besaflex®-profilele /benzi etansare fabricate din PVC plasticizat se disting prin numeroase caracteristici bune și eficiența economică. PVC-ul plasticizat se folosește din secolul 20 și se face subiectul cercetărilor constante. Acest material nu s-a folosit pentru profile /benzi etansare până când nu s-a dovedit potrivit, în urma verificărilor științifice efectuate pentru dovedirea caracteristicilor pozitive și, în special rezistența sa în timp.

Îndeplinind toate cererile necesare, profilele de etansare- Besaflex rezistă celor mai mari forțe de structură impuse. Sunt rezistente soluțiilor acide și alcaline, descompunerilor, ca și tuturor agenților naturali.

Proprietatile materialelor

Nitriflex® conform DIN 18541

Profilele /benzi etansare din Nitriflex® conform DIN 18541 sunt fabricate din materiale de cea mai buna calitate si astfel, au foarte putine restrictii, ceea ce depasesc cu mult prevederile standardelor DIN. Profilele /benzi etansare Nitriflex conform specificarilor DIN18541 sunt caracterizate prin rezistenta mare la intindere, rezistenta la solutii chimice si permanenta elasticitate asemanatoare cauciucului.

Elastoflex® conform DIN 7865

Elastoflex®- Profilele /benzi etansare sunt fabricate din elastomeri. Elastomerii sunt polimeri cu randament ridicat legati la piesele de legatura, cu o cuplare neprelucrata (cauciuc sintetic) ce au fost vulcanizati. Din cauza acestor legaturi la piesele de legatura ne-reversibile, este necesara o tehnica speciala de imbinare. Elastoflex®- Pene de etansare sunt ideale atat in structuri cat si in deplasari majore de rosturi, schimari frecvente de incarcatura si la temperaturi scazute.

Polyflex conform standardelor companiei

Polyflex-profilele de etansare au ca scop dezvoltarea in sarcinile structurale de etansare. Profilele de etansare nu au deloc deformari de conexiune si pot fi folosite pentru rosturile de etansare in beton, respectiv invelisurile de etansare din plastic.

Profilele de etansare Poliflex fabricate din PE modificat ofera avantajul unei bune sudari, rezistenta la medii chimice agresive, durabilitate ridicata si rezistenta la microbi. Elasticitatea permanenta si caracteristicile de dilatatie nu sunt afectate de temperaturile scazute.

TPE conform standardelor companiei

Profile / etansare fabricate din elastomeri termoplastici, carcatreizanduse prin rezistenta la rupere, flexibilitate la temperaturi scazute, rezistenat in timp si la radiatiile UV.



Proprietatile materialelor

Termoplastic	Besaflex	Nitriflex	Test
Duritate shore/A	75±5	67±5	DIN 53505
Rezistenta la intindere	≥ 10 N/mm ²	≥ 10 N/mm ²	DIN EN ISO 527-2
Elongatie pana la rupere	≥ 275 %	≥ 350 %	DIN EN ISO 524-2
Fabricat conform	Standard companie cu AbP1	DIN 18541	
Calitati	NB2), PH2)	DIN 18541	NB2), BV2)

Ambele materiale nu contin plumb, cadmiu si formalehida
AbP certificare test Inspectoratul General de Constructie
NB nu este compatibil cu bitum
BV este compatibil cu bitum
PH inofensiv fiziologic

Termoplastic	Elastoflex	TPE	Test
Duritate shore/A	62±5	62±5	DIN 53505
Rezistenta la intindere	≥ 10 N/mm ²	≥ 10 N/mm ²	DIN 53504
Elongatie pana la rupere	≥ 380 %	≥ 600 %	DIN 53504
Compresie	≤ 20 %	≤ 35 %	DIN ISO815
Fabricat conform	NB2), PH2)	DIN 18541	

Calitati speciale	Besaflex BS	Metoda testare	poliflex	Metoda testare
Duritate shore/A	80±5	BS 2782: Parte 3 metoda 365B	≥ 90	DIN 53505
Rezistenta la intindere	≥ 13 N/mm ²	ASTM D638M-93	≥ 17 N/mm ²	DIN EN ISO 527-2
Elongatie pana la rupere	≥ 285 %	ASTM D638M-93	≥ 700%	DIN EN ISO 524-2
Fabricat conform	Standard companie		Standard companie	



Proprietatile materialelor

Materialele pentru aplicatii de contact apa potabila

Profilele /benzi etansare Hidroplasto®- sunt concepute si au ca scop aplicatiile de contact apa potabila. Acestea sunt extrudate dintr-un elastomer termoplastic flexibil, moale, colorat sau din polietilena.

Combina proprietati bune si procesabilitate, pe langa indeplinirea reglementarilor nazionale si europene.

Materialele sunt complet reciclabile.

Caracteristici:

- material non- hidroscopic
- proprietati mecanice excelente la temperatura variabile,
- proprietati bune de retentie dupa o lunga perioada de stationare in apa,
- culoare naturala,
- indeplineste directiva EU 2003/11/EC.

Proprietati	TPE	Metoda testare	PE	Metoda testare
Duritate shore/A	62±5	ISO 868	≥ 90	ISO 868 / ASTM D 882
Rezistenta la intindere	≥ 12 N/mm ²	ISO 37 / ASTM D 421	≥ 20 N/mm ²	ISO 527 / ASTM D 882
Elongatie pana la rupere	≥ 800 %	ISO 37 / ASTM D 421	≥ 700%	ISO 527 / ASTM D 882



Profile / benzi etansare interne pentru rosturi de turnare

COTE	A	B	C	F
A100	100	40	3	10
A120	120	45	3	10
A150	150	45	3	10
A200	200	70	3	15
A240	240	80	3.5	15
A320	320	110	4.5	15
A500	500	150	6	20

COTE	A	B	C	F
A190 (1)	190	70	3,5	15
A240	240	80	4	15
A320	320	110	5	15
A500	500	120	6,5	20

(1) conf. DIN 18541 partea 2

TIP	A	B	C	F
A100	100	75	7	32
A120	120	80	8	32
A150	150	100	8	32

DIN 7865 partea 2

A240	250	80	6	32
A320	300	100	6	32
A500	350	120	6	32

COTE	A	B	C	F
AP200	200	80	3	15
AP240	240	90	3,5	15
AP320	320	110	4,5	15
AP500	500	120	6	20

COTE	A	B	C	F
CC150	150	116	5	20
CC200	200	87	5	20
CC250	250	116	6	24
CC300	300	166	7	24

Besaflex conf. standard companie

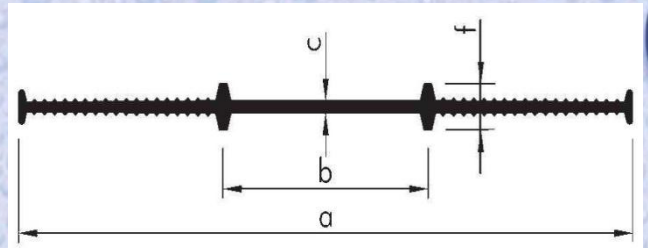

Nitriflex conf. DIN18541

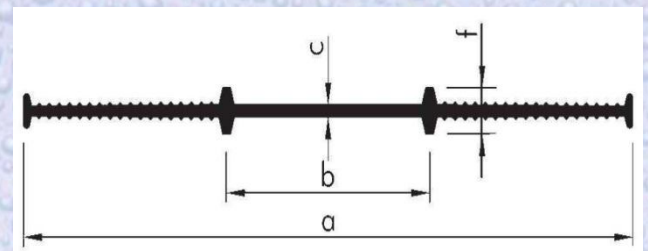

Elastoflex conf. DIN 7865

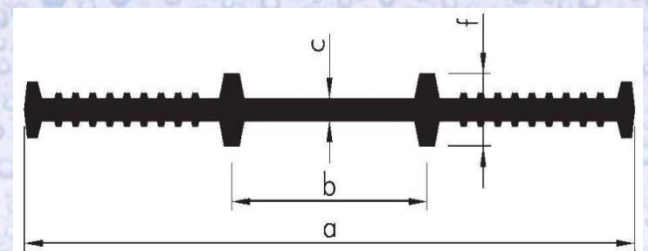

Polyflex conf. standard companie

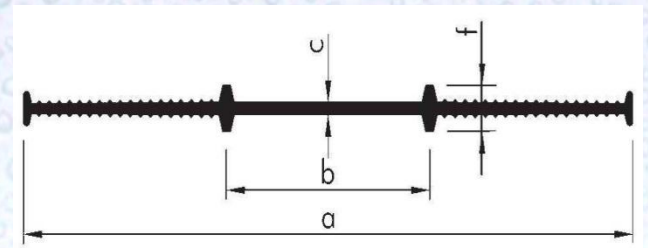

Besaflex conf. standard Marea Britanie (BS)

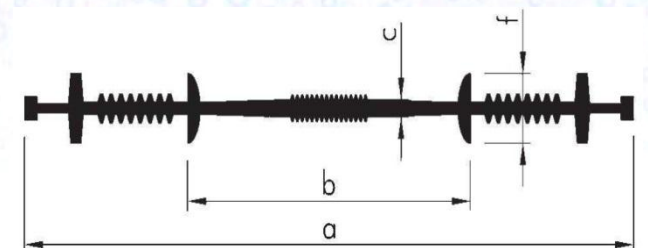

Profile / benzi etansare interne pentru rosturi de turnare

COTE	A	B	C	F
ASI 200	200	70	3,5	15
ASI240	240	80	3,5	15
ASI320	320	110	4	15

COTE	A	B	C	F
ASI 200 D (1)	200	70	3,5	15
ASI 240 D	240	80	3,5	15
ASI 320 D	320	110	4	15

(1) conf DIN 18541 partea 2

COTE	A	B	C	F
AS 100	100	50	3	10
AS 120	120	60	3	10
AS 150	150	60	3	10
AS 200	200	70	3,5	15
AS 240	240	80	3,5	15
AS 320	320	100	4,5	15

COTE	A	B	C	F
AS 200 D (1)	200	70	3,5	15
AS 240 D	240	80	4	15
AS 320 D	320	100	5	15

(1) conf DIN 18541 partea 2

COTE	A	B	C	F
A 260 DBS	260	120	9	26
A 260 DBS	320	165	10	26
A 260 DBS	400	190	11	60

COTE	A	B	C	F
AS 100	100	50	3	10

Besaflex conf. standard companie cu armatura de otel interna

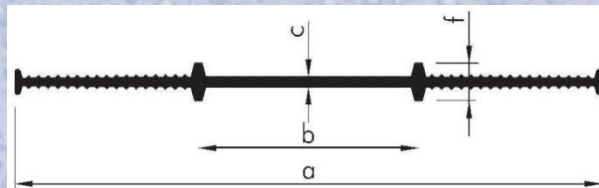

Nitriflex conf. DIN18541 cu armatura de otel interna

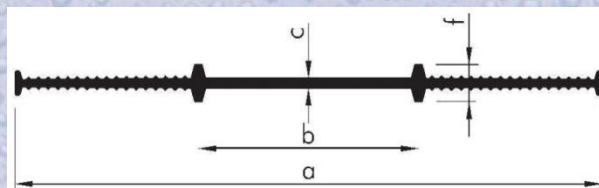

Besaflex conf. standard companie cu armatura de otel externa

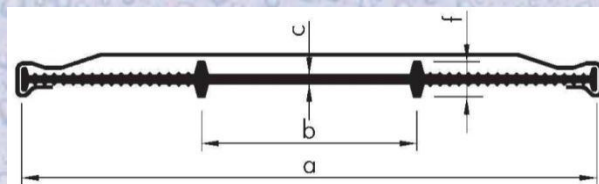

Nitriflex conf. DIN18541 cu armatura de otel externa

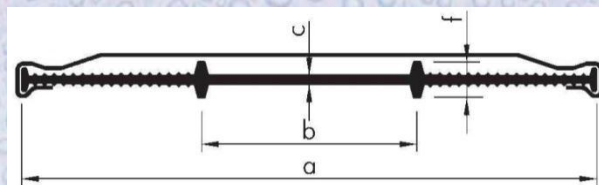

Nitriflex conf. DIN18541

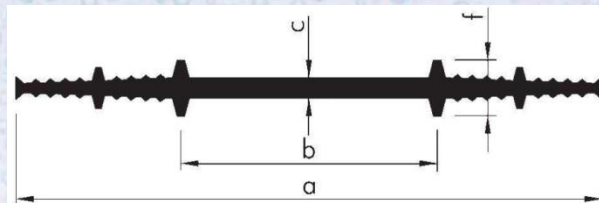

Elastoflex conf. DIN 7865 cu placi de otel

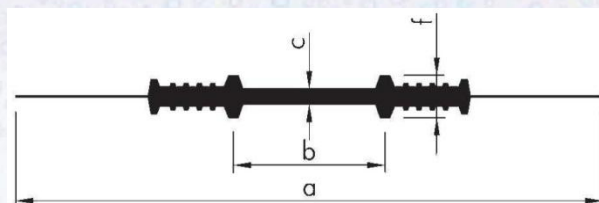



Profile / benzi etansare interne pentru rosturi de dilatatie

COTE	A	B	C	F	K
D 120	120	70	3	10	10
D 150	150	70	3	10	10
D 200	200	90	3,5	15	10
D 240	240	90	4	15	20
D 320	320	110	5	15	20
D 350	350	120	5	15	20
D 500	500	150	6	20	20

Besaflex conf standard companie

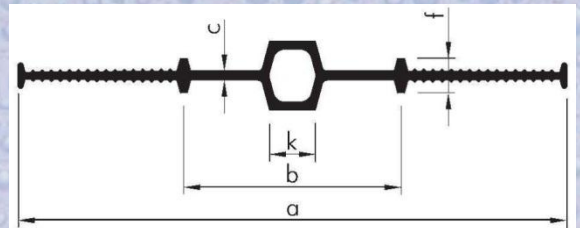

COTE	A	B	C	F	K
D 190 (1)	190	75	4	15	10
D 240	240	95	4,5	15	20
D 240/6	240	95	6	25	20
D 240/9	240	95	9	25	20
D 320	320	110	5,5	15	20
D 320/6	320	110	6	25	20
D 320/9	320	110	9	25	20
D 350	350	120	6	15	20
D 500	500	155	6,5	20	20

Nitriflex conf. DIN18541

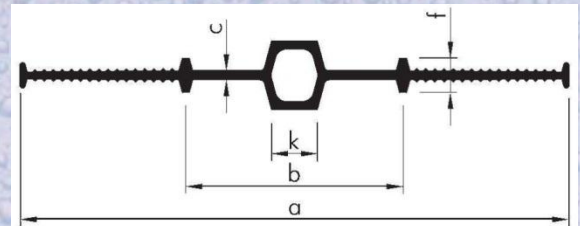

(1) conf. DIN 18541 partea 2

COTE	A	B	C	F	K
FM 200	200	110	7	32	20
FM 250	250	125	8	32	20
FM 300	300	175	8	32	20
FM 350	350	180	12	38	20
FM 400	400	210	12	38	20
FM 500	500	300	13	38	20

Elastoflex conf. DIN 7865

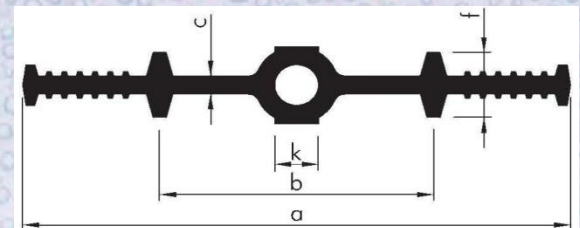

DIN 7865 partea 2

FM 250-2	250	125	6	26	20
FM 300-2	300	175	6	28	20
FM 350-2	350	180	6	30	20

Polyflex conf. standard companie

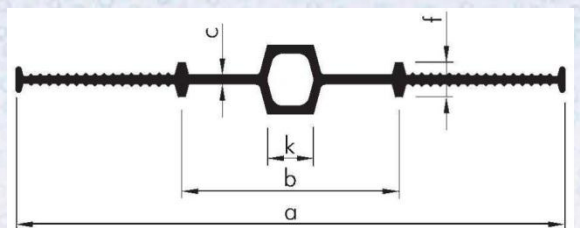

COTE	A	B	C	F	K
FM 200	200	110	7	32	20
FM 250	250	125	8	32	20
FM 300	300	175	8	32	20
FM 350	350	180	12	38	20

Profile /benzi etansare interne pentru rosturi de dilatatie

COTE	A	B	C	F	K
CE 150	150	116	5	20	20
CE 200	200	87	5	20	20
CE 250	250	116	6	24	20
CE 300	300	166	7	24	20

Besaflex conf. standard Marea Britanie (BS)

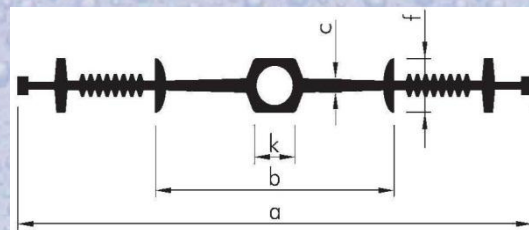

COTE	A	B	C	F	K
D 260 DBS	260	120	9	28	20
D 350 DBS	350	170	11	30	20
D 400 DBS	400	190	11	32	20

Nitriflex conf. DIN18541

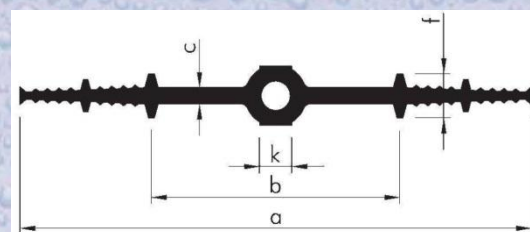

COTE	A	B	C	F	K
FMS 350	350	120	10	32	20
FMS 400	400	170	11	32	20
FMS 500	500	230	13	32	20

Elastoflex conf. DIN 7865

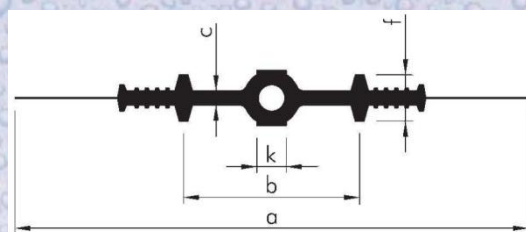

COTE	A	B	C	F	K
FM 400 DS	400	170	11	35	20
FM 500 DS	500	230	13	35	20

Elastoflex conf. DIN 7865

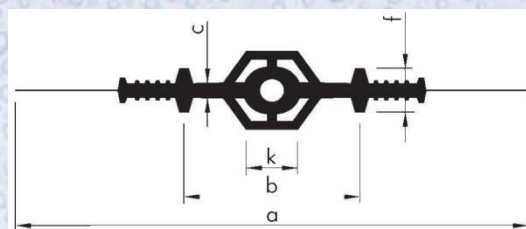

COTE	A	B	C	F	K
FM 350 DS	500	230	13	35	20

Elastoflex conf. DIN 7865

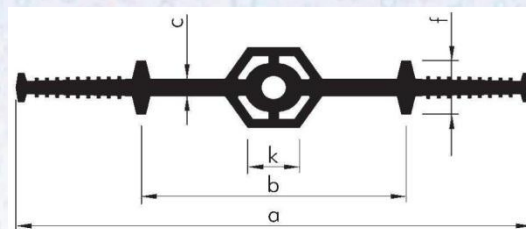



Profile / benzi etansare externe pentru rosturi de turnare

TIP	A	B	C	F	ANCORA
AA 200	200	80	3,5	20	4
AA 250	240	90	4	25	4
AA 250/35	240	90	4,5	35	4
AA 250/45	240	90	4,5	45	4
AA 320	320	110	4	25	6
AA 320/35	320	110	4,5	35	6
AA 320/45	320	110	4,5	45	6
AA 500	500	120	4	25	8
AA 500/35	500	120	4,5	35	8
AA 625/35	625	300	5,5	35	10
AA 800	800	300	5,5	25	12

Besaflex conf standard companie

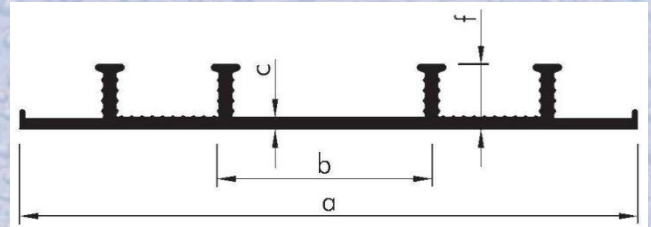

TIP	A	B	C	F	ANCORA
AA 240/25	200	80	4,5	25	4
AA 240/35	240	90	5	35	4
AA 320/25	240	90	5	45	4
AA 320/25	240	90	4,5	45	4
AA 320/35	320	110	4	25	6
AA 320/45	320	110	4,5	35	6
AA 500/25	320	110	4,5	45	6
AA 500/35	500	120	4	25	8

Nitriflex conf. DIN18541

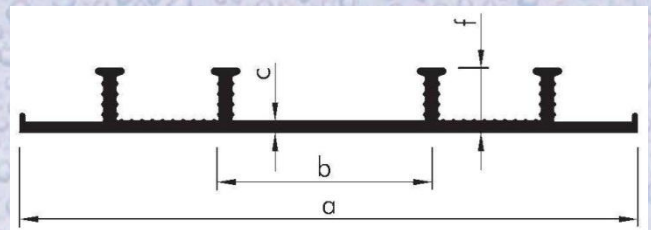

TIP	A	B	C	F	ANCORA
A 250	250	100	6	31	4
A 350	350	100	6	31	6
A 500	500	150	6	31	8
DIN 7865 partea 2					
A 250-2	250	100	5,5	30	4

Elastoflex conf. DIN 7865

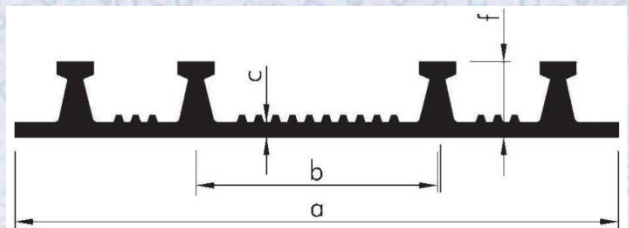

TIP	A	B	C	F	ANCORA
AAP 240	240	90	4	25	4
AAP 320	320	110	4	25	5

Polyflex conf. standard companie

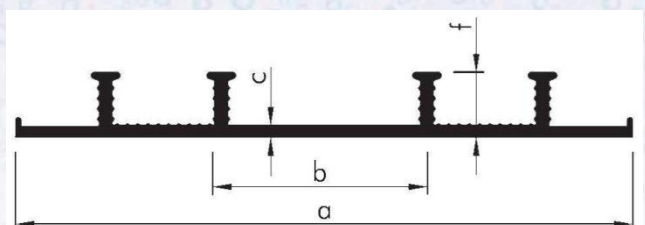



Profile / benzi etansare externe pentru rosturi de turnare

TIP	A	B	C	F	ANCORA
EC 150	150	110	4,5	24	2
EC 200	200	85	4,5	24	4
EC 250	250	110	4,5	24	4
EC 300	300	140	4,5	24	4
EC 330	330	170	4,5	24	4

Besaflex conf. standard Marea Britanie (BS)

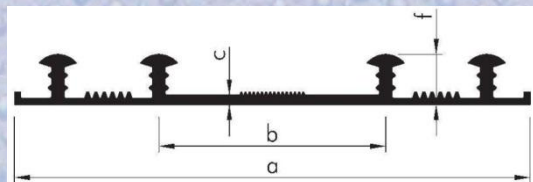

Tip	a1	a2	b1	b2	Ancora
AA 240 EA	120	120	45	45	4
AA 240 EW	120	120	45	45	4
AA 320 EA	170	170	55	55	6
AA 320 EW	170	170	55	55	6
AA 320 EI	170	170	100	100	4
AA 500 EA	250	250	85	85	8
AA 500 EW	250	250	85	85	8
AA 500 EI	250	250	85	85	8

Besaflex conf standard companie

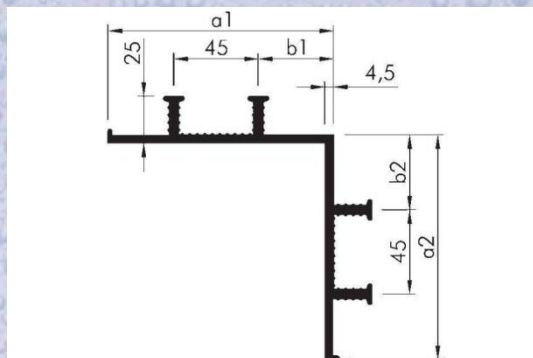

Tip	a1	a2	b1	b2	Ancora
AA 240 EA	120	120	45	45	4
AA 240 EW	120	120	45	45	4
AA 320 EA	170	170	55	55	6
AA 320 EW	170	170	55	55	6
AA 320 EI	170	170	100	100	4
AA 500 EA	250	250	85	85	8
AA 500 EW	250	250	85	85	8
AA 500 EI	250	250	85	85	8

Nitriflex conf. DIN18541

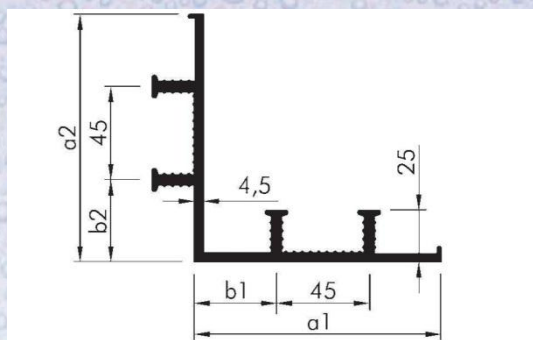

Besaflex conf. standard Marea Britanie (BS)

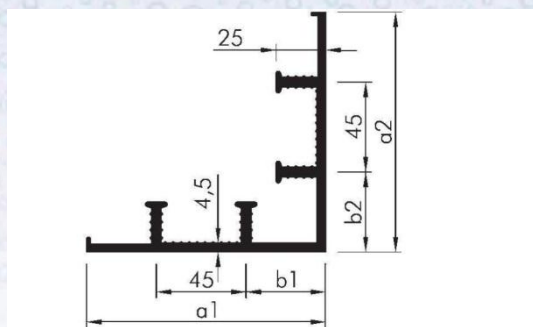

Tip	a1	a2	b2	Ancora
EC 240 EA	120	120	45	4
EC 240 EW	120	120	45	4



Profile / benzi etansare exderne pentru rosturi de dilatatie

Tip	a	b	c	f	Ancora
AD 200	200	80	3,5	20	4
AD 250	240	90	4	25	4
AD 250/35	240	90	4,5	35	4
AD 250/45	240	90	4,5	45	4
AD 320	320	110	4	25	6
AD 320/35	320	110	4,5	35	6
AD 320/45	320	110	4,5	45	6
AD 500	500	120	4	25	8
AD 500/35	500	120	4,5	35	8

Besaflex conf standard companie

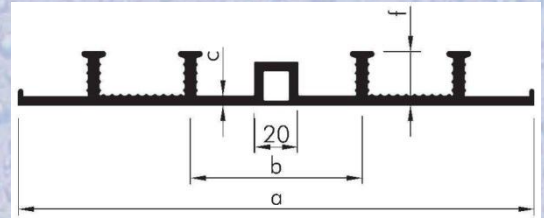

Tip	a	b	c	f	Ancora
DA 240/25	240	90	4,5	25	4
DA 240/35	240	90	5	35	4
DA 240/45	240	90	5	45	4
DA 320/25	320	110	4,5	25	6
DA 320/35	320	110	5	35	6
DA 320/45	320	110	5	45	6
DA 500/25	500	120	4,5	25	8
DA 500/35	500	120	5	35	8

Nitriflex conf. DIN18541

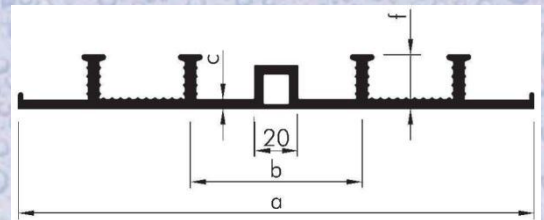

Tip	a	b	c	f	Ancora
AM 250	250	100	6	31	4
AM 350	350	100	6	31	6
AM 500	500	150	6	31	8

DIN 7865 partea 2

AM 250-2	250	100	5,5	30	4
----------	-----	-----	-----	----	---

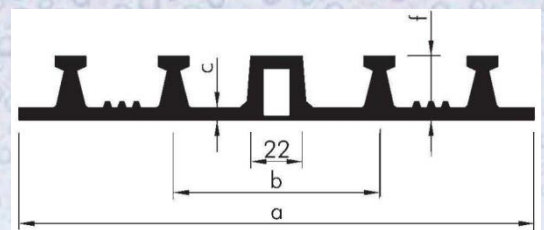

Tip	a	b	c	f	Ancora
ADP 240	240	90	4	25	4
ADP 320	320	110	4	25	6

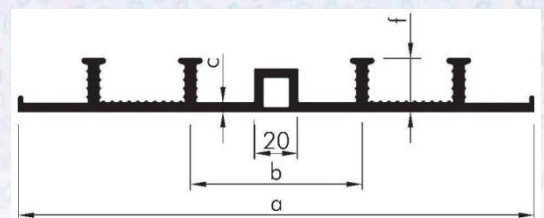

Profile / benzi etansare exderne pentru rosturi de dilatatie

Tip	a	b	c	f	Ancora
EE 150	150	110	4,5	24	2
EE 200	200	85	4,5	24	4
EE 250	250	110	4,5	24	4
EE 300	300	140	4,5	24	4
EE 330	330	170	4,5	24	4

Besaflex conf. standard Marea Britanie (BS)

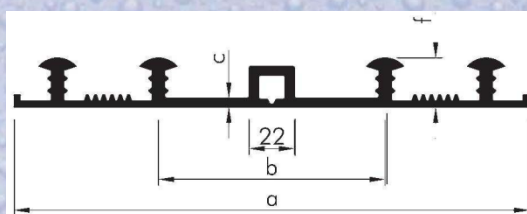

Tip	a1	a2	b1	b2	Ancora
AD 240 EA	120	120	50	50	4
AD 240 EW	120	120	50	50	4
AD 320 EA	170	170	60	60	6
AD 320 EW	170	170	60	60	6
AD 500 EA	250	250	90	90	8
AD 500 EW	250	250	90	90	8

Besaflex conf standard companie

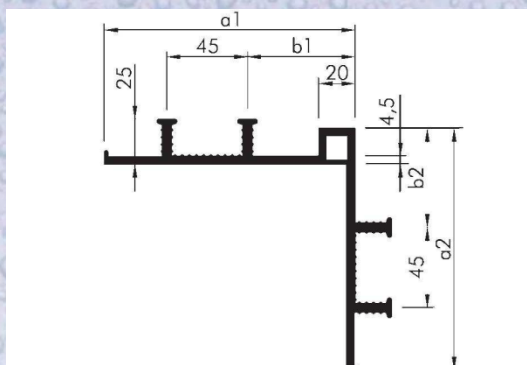

Tip	a1	a2	b1	b2	Ancora
DA 240 EA	120	120	50	50	4
DA 240 EW	120	120	50	50	4
DA 320 EA	170	170	60	60	6
DA 320 EW	170	170	60	60	6
DA 500 EA	250	250	90	90	8
DA 500 EW	250	250	90	90	8

Nitriflex conf. DIN18541 partea 2

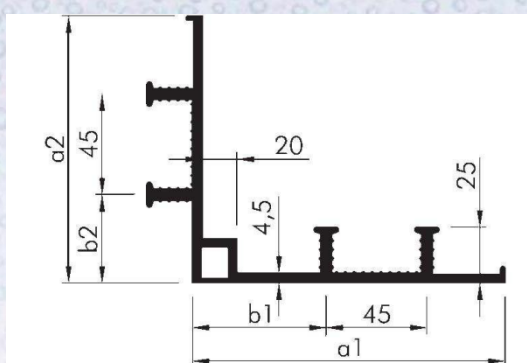



Profile / benzi etansare exderne pentru rosturi de dilatatie

Tip	a	b	k	d	f	Ancora
FV 20/20	50	20	10	5	25	2
FV 20/20/70	70	20	10	5	25	2
FV 20/30	50	20	10	5	35	2
FV 20/40	70	20	10	5	45	2
FV 30/20	50	30	20	5	25	2
FV 30/30	50	30	20	5	35	2
FV 30/40	70	30	20	5	45	2
FV 40/40	70	40	30	5	45	2
FV 50/40	70	50	40	5	45	2
FV 30/20/2	95	30	20	5	25	4
FV 30/30/2	95	30	20	5	35	4
FV 40/30/2	95	40	30	5	35	4
FV 60/30/2	140	60	50	5	35	4
FV 30/20/3	140	30	20	5	25	6
FV 30/30/3	140	30	20	5	35	6
FV 30/40/3	140	30	20	5	45	6
FV 40/30/3	140	40	30	5	35	6
FV 70/20/3	140	70	60	5	25	6
FV 80/20/3	140	80	70	5	25	6
FV 110/20/3	140	110	100	5	25	6

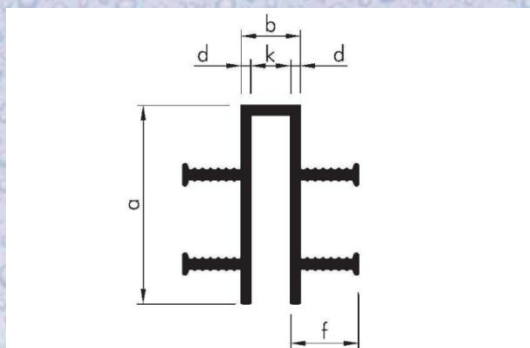
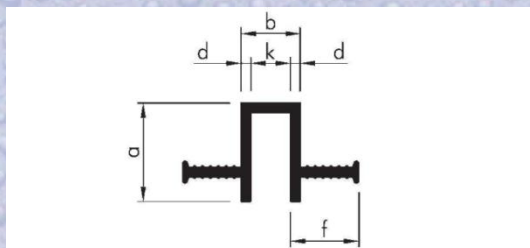

Tip	a	b	k	d	f	Ancora
FA 50/10/25 1)5020	50	20	10	5	25	2
FA 70/10/25 1)7020	70	20	10	5	25	2
FA 50/10/35 1)5020	50	20	10	5	35	2
FA 70/10/45 1)7020	70	20	10	5	45	2
FA 50/20/2550	50	30	20	5	25	2
FA 50/20/3550	50	30	20	5	35	2
FA 70/20/4570	70	30	20	5	45	2
FA 70/30/4570	70	40	30	5	45	2
FA 70/40/4570	70	50	40	5	45	2
FA 90/20/2595	95	30	20	5	25	4
FA 90/20/3595	95	30	20	5	35	4
FA 90/30/3595	95	40	30	5	35	4
FA 130/50/35 1)14060	140	60	50	5	35	4
FA 130/20/25140	140	30	20	5	25	6
FA 130/20/35140	140	30	20	5	35	6
FA 130/20/45140	140	30	20	5	45	6
FA 130/30/35140	140	40	30	5	35	6
FA 130/60/25140	140	70	60	5	25	6
FA 130/70/25140	140	80	70	5	25	6
FA 130/100/25140	140	110	100	5	25	6

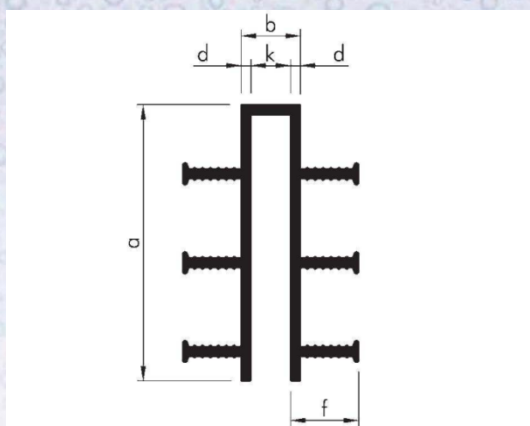

1)DIN 18541 partea 2

Profile de compresie



Tip	Rost	b	a
KLP 10	13-17	17	20
KLP 15	17-22	20	20
KLP 20	19-25	25	25
KLP 25	19-25	30	30
KLP 30	19-25	50	30
KLP 35	25-34	35	35
KLP 40	24-29	60	40
KLP 50	24-29	50	40
KLP 55	34-40	55	45
KLP 60	19-24	60	50
KLP 90	25-34	90	60
KLP 35 Colt	19-24	40	35
KLP 90 Colt	25-34	100	35

Nitriflex conf. DIN18541 partea 2

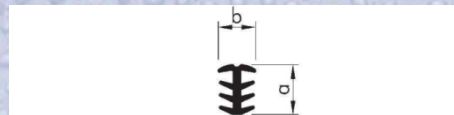

KLP 10

TPE conform Standard companie

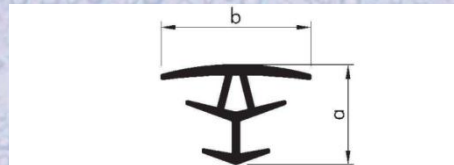

KLP 40

TPE conform Standard companie

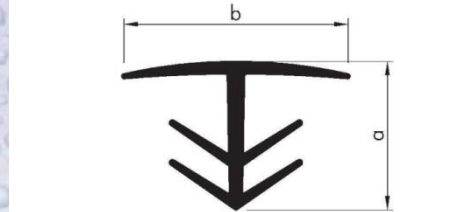

KLP 15
KLP 25
KLP 30
KLP 35
KLP 50
KLP 90

TPE conform Standard companie

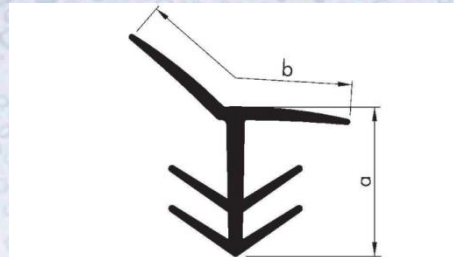

KLP 35 COLT
KLP 60 COLT

TPE conform Standard companie

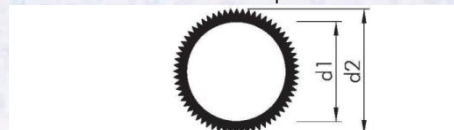

Tip	rost	b	a
KLP-TPE 10	13-17	17	20
KLP-TPE 15	17-22	20	20
KLP-TPE 20	19-25	25	25
KLP-TPE 25	19-25	30	30
KLP-TPE 30	19-25	50	30
KLP-TPE 35	25-34	35	35
KLP-TPE 40	24-29	60	40
KLP-TPE 50	24-29	50	40
KLP-TPE 55	34-40	55	45
KLP-TPE 60	19-24	60	50
KLP-TPE 90	25-34	90	60
KLP-TPE 35 Colt	19-24	40	35
KLP-TPE 90 Colt	25-34	100	35

Tip	d1	d2
KLS 10/30	40	50



Profile de compresie

Tip	rost	b	a
KLM 10	7-12	15	20
KLM 20	12-17	20	20
KLM 25	17-21	25	27
KLM 30	18-24	30	28
KLM 40	28-34	40	35
KLM 50	38-44	50	40
KLM 60	48-54	60	45
KLM 70	58-64	70	45
KLM 80	68-74	80	60
KLM 120	85-105	120	75



Tip	rost	b	a
KLM-TPE 10	7-12	15	20
KLM-TPE 20	12-17	20	20
KLM-TPE 25	17-21	25	27
KLM-TPE 30	18-24	30	28
KLM-TPE 40	28-34	40	35
KLM-TPE 50	38-44	50	40
KLM-TPE 60	48-54	60	45
KLM-TPE 70	58-64	70	45
KLM-TPE 80	68-74	80	60
KLM-TPE 120	85-105	120	75

Nitriflex conf. DIN18541 partea 2

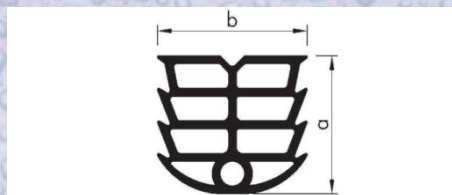

KLM-TPE

KLM-TPE

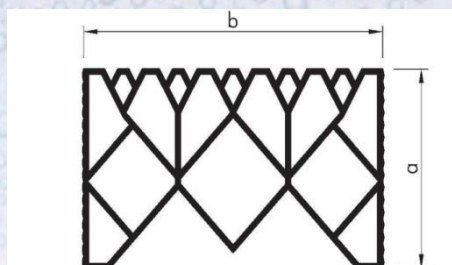

Tip	rost	b	a
HK 15	10	15	18
HK 18	12	18	20
HK 21	15	21	22
HK 24	18-20	24	22
HK 30	22-24	30	28
HK 40	25-30	40	30
HK 50	30-40	50	38
HK 60	40-50	60	48
HK 75	50-60	75	60



Profile / benzi etansare speciale

tip	a	c
FL 100	100	4
FL 200	200	4
FL 250	250	4
FL 280	280	4
FL 300	300	4
FL 350	350	4
FL 400	400	4
FL 500	500	4

Elastoflex conf. DIN7865 partea 2



Nitriflex conf. DIN18541 partea 2

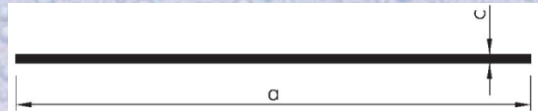

Nitriflex conf. DIN18541 partea 2

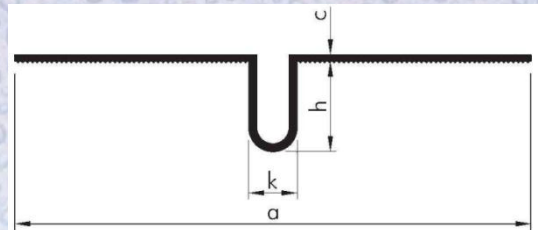

Nitriflex conf. DIN18541 partea 2

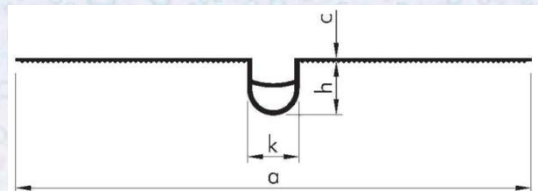

Tip	a	c
FLK 100	100	4
FLK 200	200	4
FLK 250	250	4
FLK 280	280	4
FLK 300	300	4
FLK 350	350	4
FLK 400	400	4
FLK 500	500	4

Tip	a	c	k	h
BOD 240	240	5	30	50
BOD 320	320	5	30	55
BOD 360	360	5	35	55
BOD 500	500	6	50	55

Tip	a	c	k	h
BOD 300	300	2,5	28	30
BOD 400	400	5	80	25



Profile / benzi etansare speciale

KFB 330
Elastoflex® conform DIN 7865, Parte 2

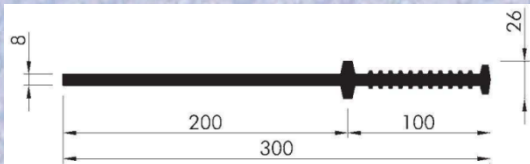

A 450 KL
Elastoflex® conform DIN 7865, Parte 2

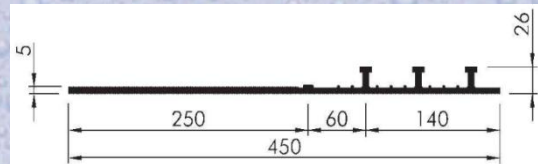

AA 240 o parte neteda
Nitriflex® conform DIN 18541, Parte 2

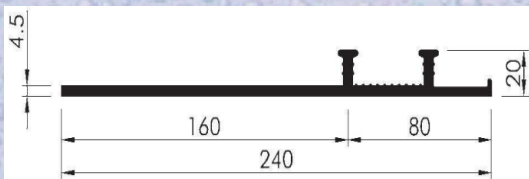

AA 320 o parte neteda
Nitriflex® conform DIN 18541, Parte 2

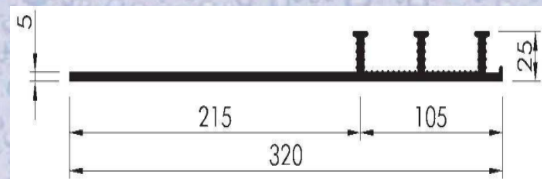

FM 350 KF
Elastoflex® conform DIN 7865, Parte 2

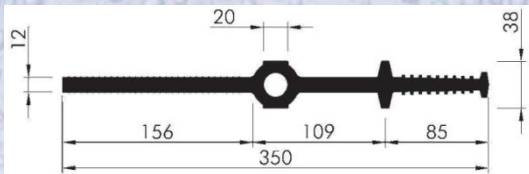

AM 350 o parte neteda
Elastoflex® conform DIN 7865, Parte 2

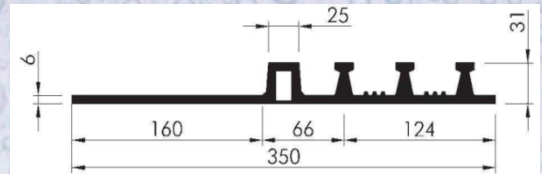

DA 240 o parte neteda
Nitriflex® conform DIN 18541, Parte 2

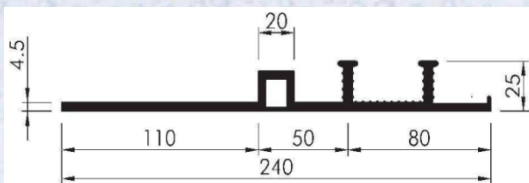

DA 320 o parte neteda
Nitriflex® conform DIN 18541, Parte 2

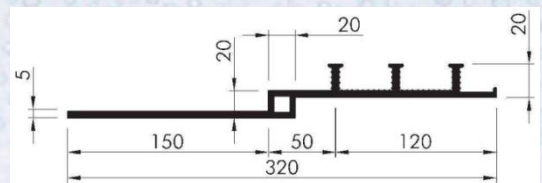



Profile / benzi etansare speciale

D 330 Colt o parte neteda
Nitriflex® conform DIN 18541, Parte 2

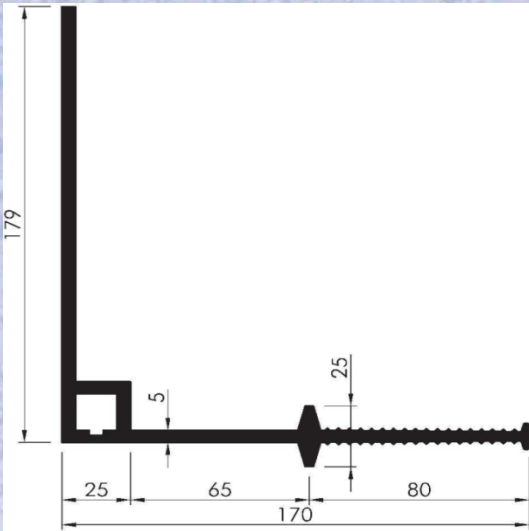

FM 350 K
Elastoflex® conform DIN 7865, Parte 2

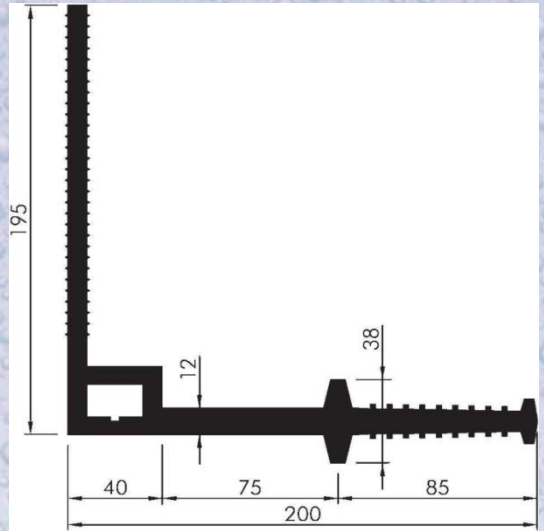

FM 350 K
Elastoflex® conform DIN 7865, Parte 2

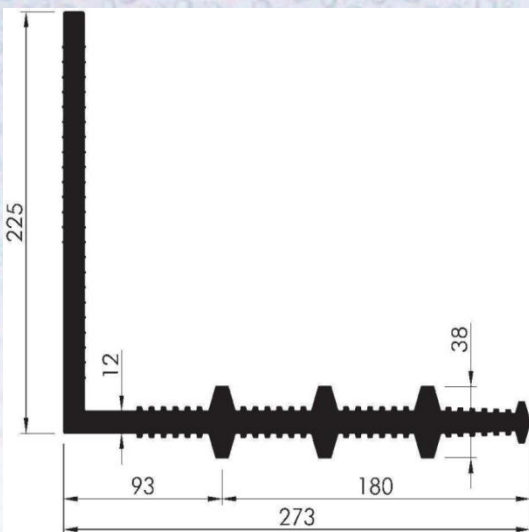

FM 500 K
Elastoflex® conform DIN 7865, Parte 2

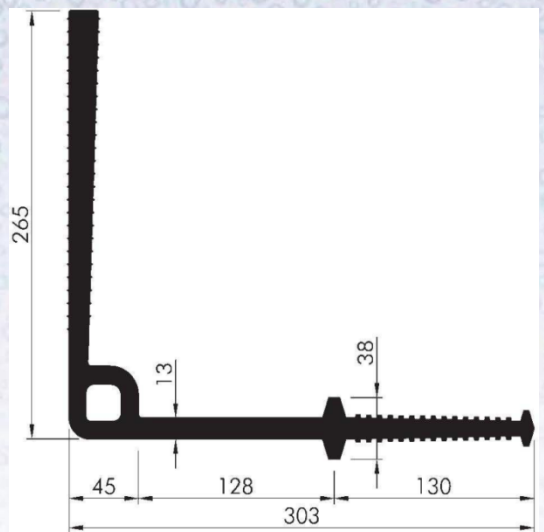



Profile / benzi etansare speciale

DA 330/35 Colt o parte neteda
Nitriflex® conform DIN 18541, Parte 2

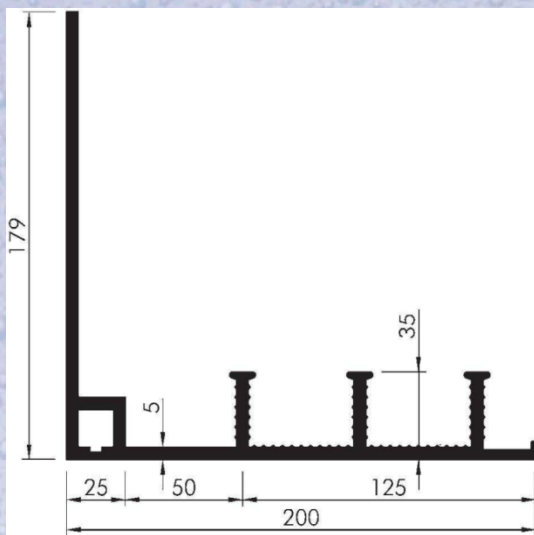

DA 330/35 Colt A o parte neteda
Nitriflex® conform DIN 18541, Parte 2

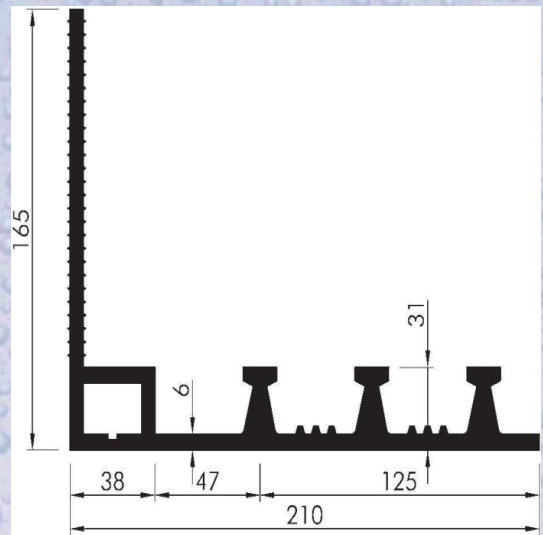

AM 350 K
Elastoflex® conform DIN 7865, Parte 2

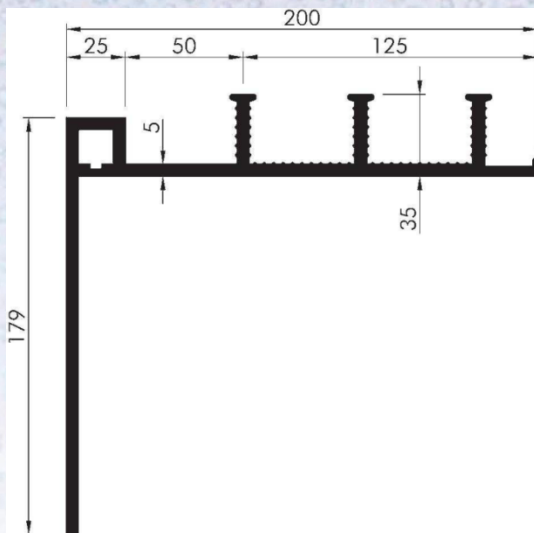

AM 350 KA
Elastoflex® conform DIN 7865, Parte 2

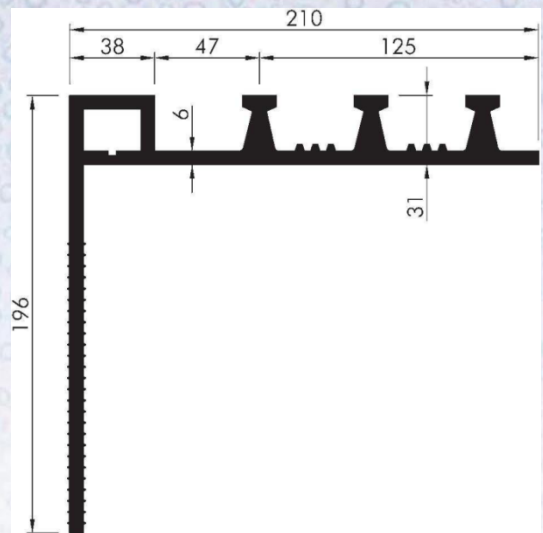



Profile / benzi etansare speciale

DA 320 ambele parti netede
Nitriflex® conform DIN 18541, Parte 2

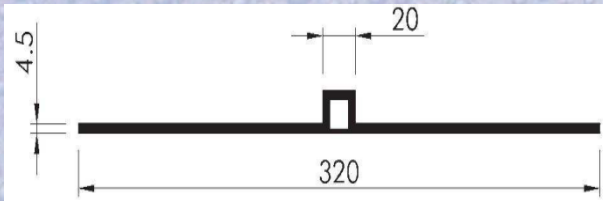

AMG 350
Elastoflex® conform DIN 7865, Parte 2

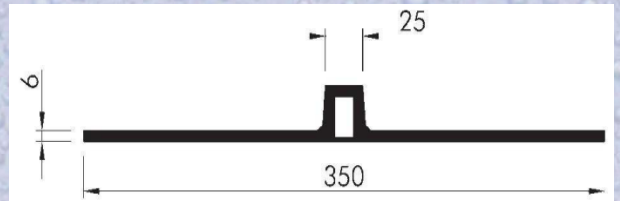

Omega 380
Elastoflex® conform DIN 7865, Parte 2

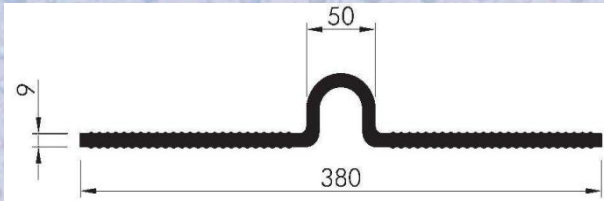

Omega 380 cu material incorporat
Elastoflex® conform DIN 7865, Parte 2

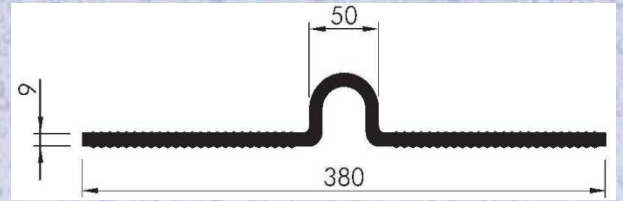

A 500 KL
Elastoflex® conform DIN 7865, Parte 2

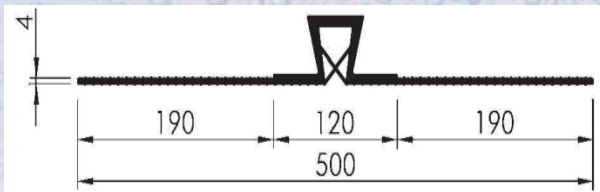

FM 350 KF2
Elastoflex® conform DIN 7865, Parte 2

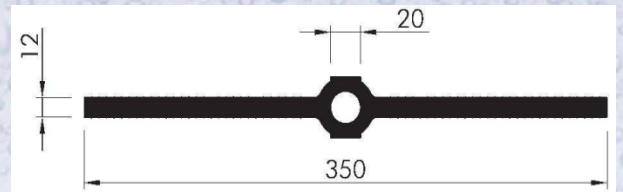



Profile / benzi etansare speciale

OK 25
Elastoflex® conform DIN 7865, Parte 2

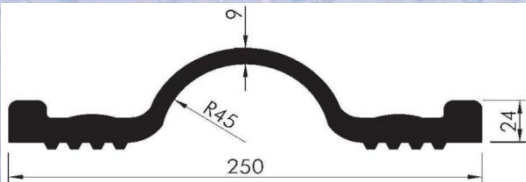

OKB 30 plat cu material incorporat
Elastoflex® conform DIN 7865, Parte 2

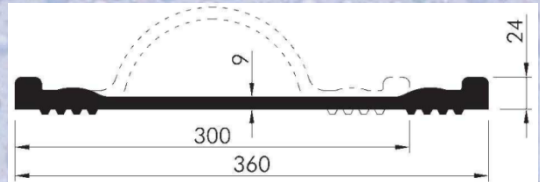

OK 30
Nitriflex® conform DIN 7865, Parte 2

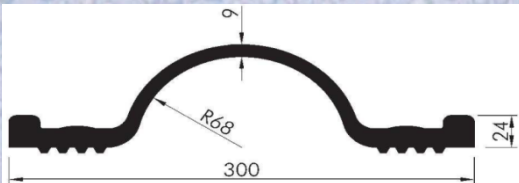

OKB 35 plat cu material incorporat
Elastoflex® conform DIN 7865, Parte 2

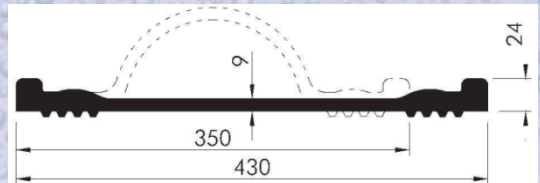

OK 35
Elastoflex® conform DIN 7865, Parte 2

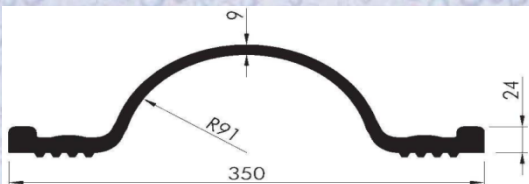

OKB 30 cu material incorporat
Elastoflex® conform DIN 7865, Parte 2

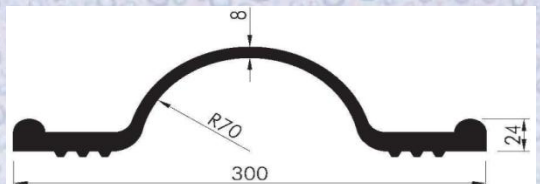



Profile / benzi etansare interne pentru crapaturi controlate

Tuburile de ingustare Hidroplasto®-st folosite pentru a crea puncte de concasare predeterminate in structurile de beton. Elementul structural este asadar, slabit si etansat de ancore. In combinatie cu profilurile triunghi (vezi accesoriile cofrajului) care sunt folosite in exteriorul elementelor structurale, straturile fisurate vor fi netede

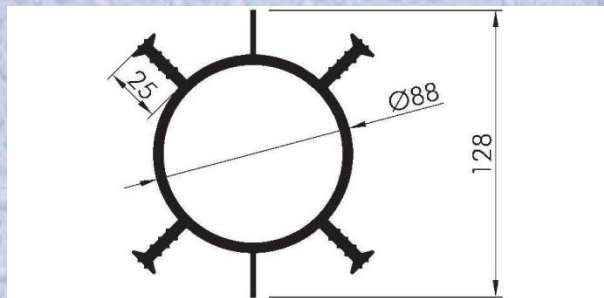

Material: Besaflex®

Grosimea peretelui: 240 pana la 350 mm

Lungime standard: 2,50 m; 2,75 m; 3,00 m; 4,00 m; 5,00 m

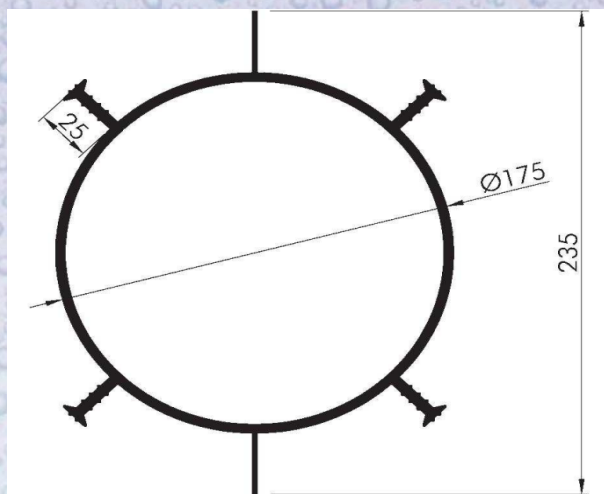

Material: Besaflex®

Grosimea peretelui: 350 pana la 500 mm

Lungimea standard: 2,50 m; 3,00 m; 4,00 m; 5,00 m

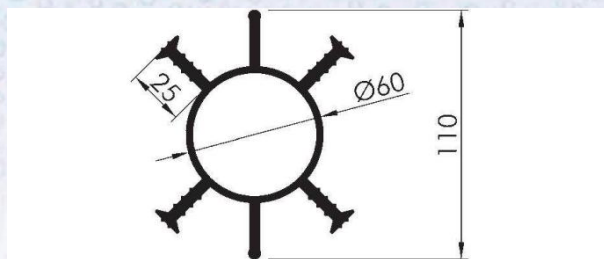

Material: Besaflex®

Grosimea peretelui: 170 pana la 240 mm

Lungimea standard: 2,50 m; 2,75 m; 3,00 m; 4,00 m; 5,00 m



Produse speciale pentru Constructii

HIDROPLASTO

WWW.HIDROPLASTO.RO

Profile / benzi etansare interne pentru crapaturi controlate

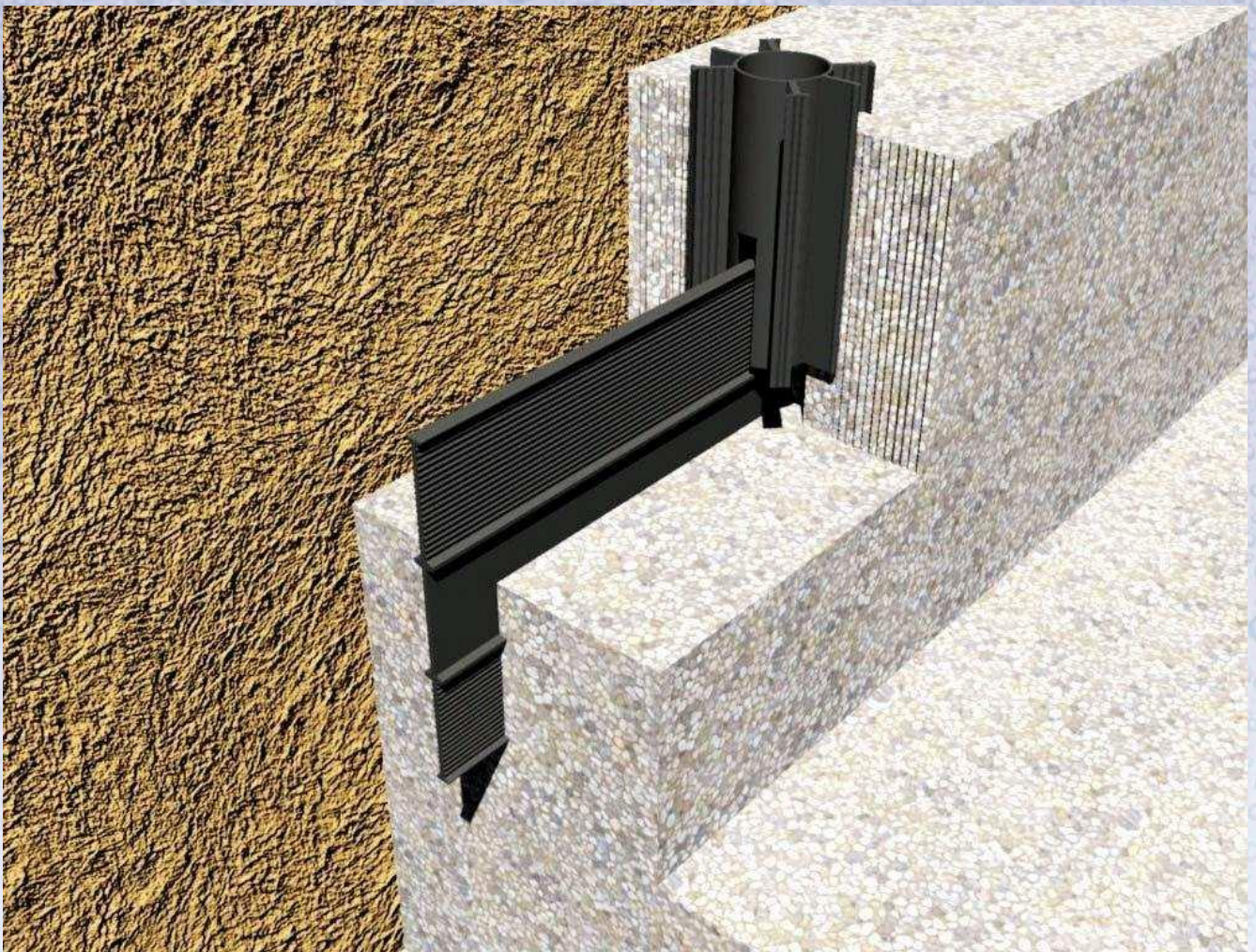

Profile / benzi etansare externe pentru rost de turnare

Tip	a	e	c	f	Ancora
FAP 60	60	40	4	20	2
FAP 80	80	50	4	20	2
FAP 100	100	60	4	20	2
FAP 140/3	140	50	4	20	3
FAP 140/30/3	140	50	4	30	3

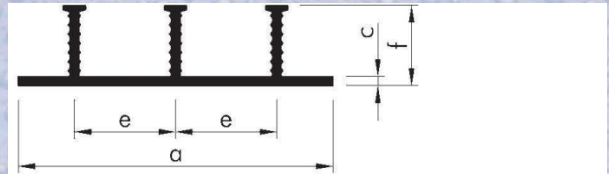

Tip	a	e	c	f
FAPN 60	60	40	4	20
FAPN 80	80	50	4	20
FAPN 100	100	60	4	20
FAPN 140/3	140	50	4	20
FAPN 140/30/3	140	50	4	30

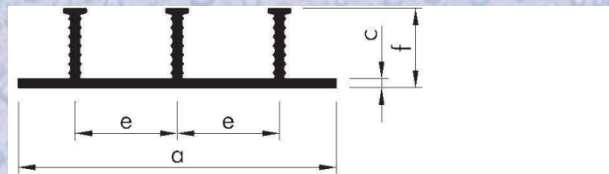

Tip	a	e	c	f	Ancora
AAP 60	60	40	4	20	2
AAP 80	80	50	4	20	2
AAP 100	100	60	4	20	2
AAP 140/3	140	50	4	20	3
AAP 140/30/3	140	50	4	30	3

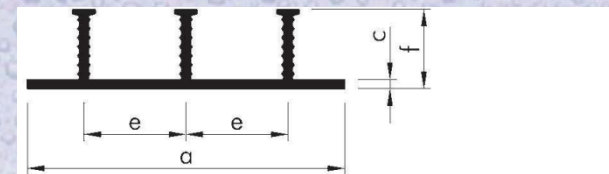

Tip	a	b	c	f	Ancora
SAA 400	400	110	4	30	6
SAA 500	500	170	4	30	6
SAA 600	600	270	4	30	6

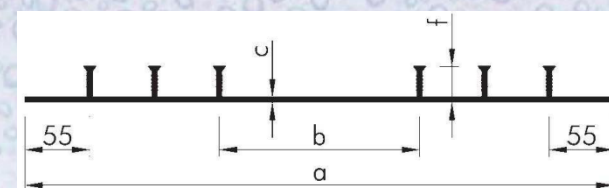

Tip	a	b	c	f	Ancora
SDA 400	400	110	4	30	6
SDA 500	500	170	4	30	6

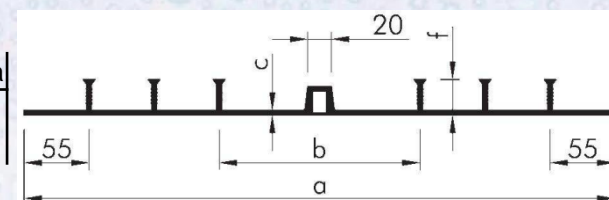



Profile / benzi etansare externe pentru rost de turnare

Colier racord conform Modul 853.4101 SA 165

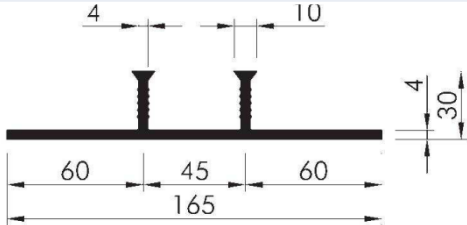

Colier racord conform Modul 853.4101 SA 210

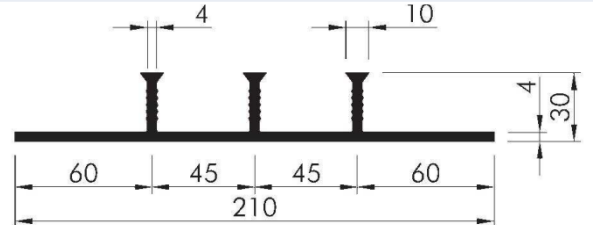

Colier racord conform Modul 853.4101 SAA 500

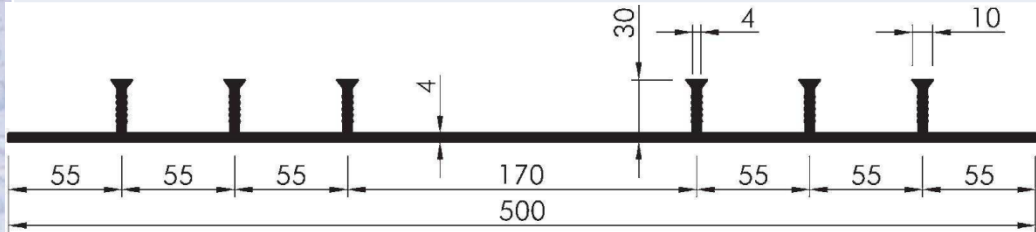

Colier racord conform Modul 853.4101 SAA 600

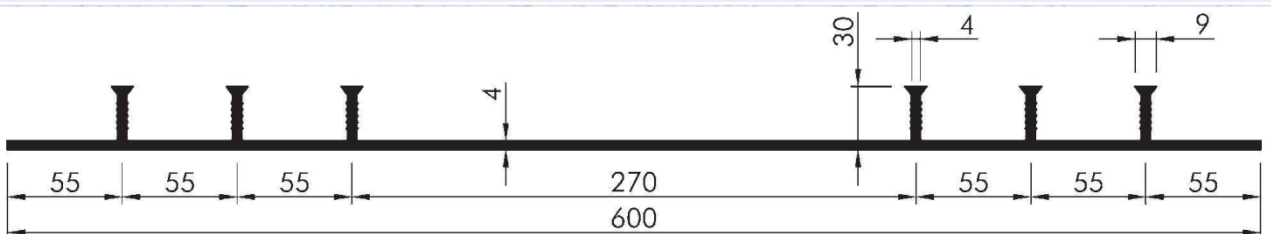



Produse speciale pentru Constructii

HIDROPLASTO

WWW.HIDROPLASTO.RO

Benzi hidrofiele

Benzile hidrofiele sunt folosite pentru etansarea rosturilor de constructie. Acestea isi maresc de pana la 8 ori volumul in contact cu apa si astfel hidroizoleaza rostul de turnare

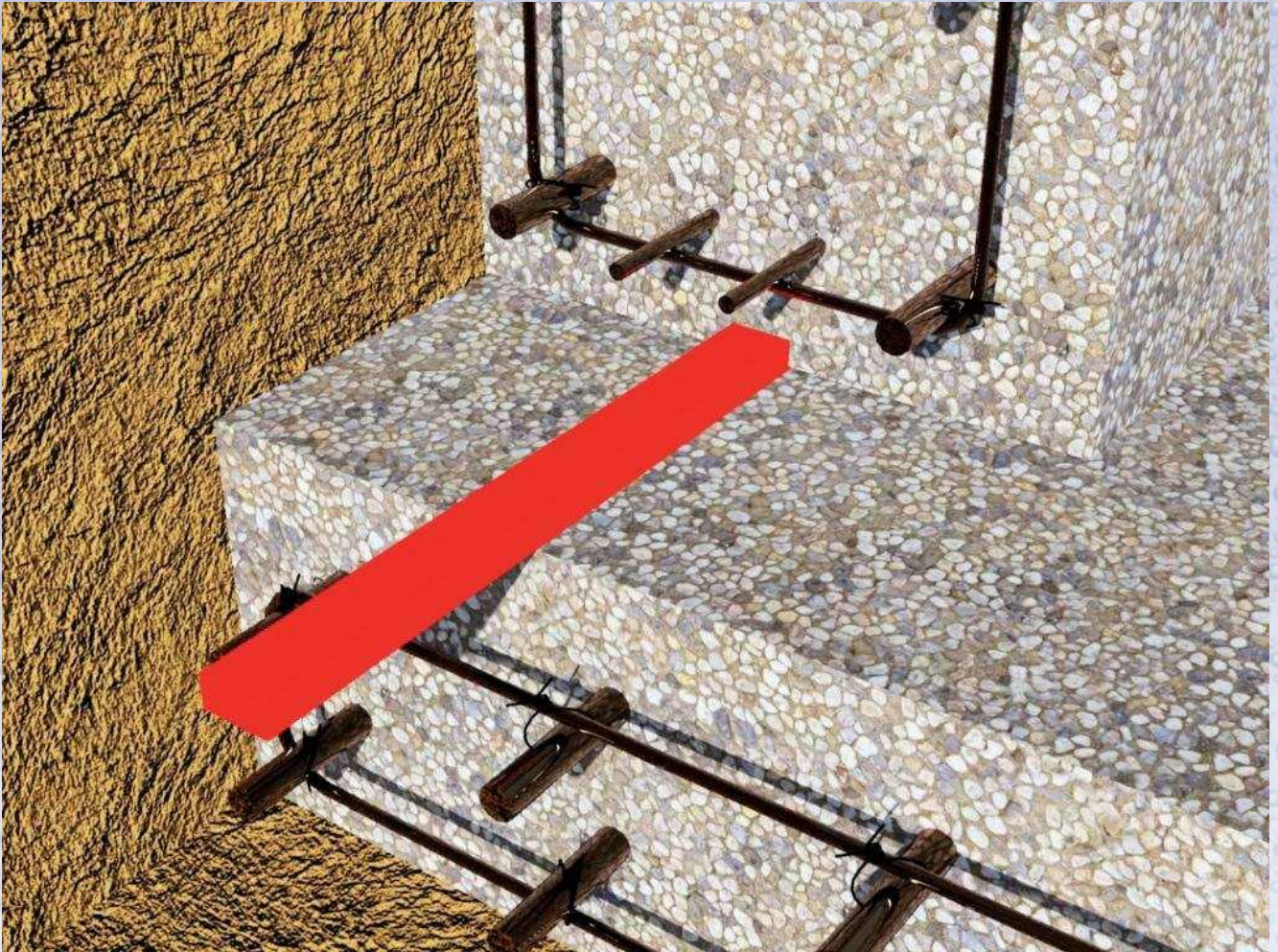



Benzi hidrofite

Domeniu aplicare:

Cauciucul de dilatare Hidroplasto®-este folosit in rosturile de constructie pentru etansare impotriva apei cu presiune si indiguite.

Material:

Cauciucul nostru de dilatare este fabricat din elastomer termoplastic (TPE). Datorita materialului sau extrem de elastic este posibila o sudare de pana la 300%. Astfel, rosturile sunt etansate fara fisuri.

Inainte de instalare:

-cauciucul de dilatare ar trebui sa fie pastrat in locuri sigure si uscate. Altfel, procesul de dilatare va incede inainte de instalare iar sigilarea finala va esua.

-Montarea trebuie sa se faca moderat, in beton.

Doar astfel, se evita dilatarea anticipata.

Instalare:

-Suprafata trebuie sa fie curata.

-apa statatoare trebuie sa fie evacuata.

-asperitatile trebuie slefuite.

Explicatii de constructie:

-Invelisul de beton trebuie s afie mai mare de 10 cm.

-pozitionarea trebuie s afie in mijlocul partii structurale.-

fixarea se face cu gluten sau mechanic. Distanța nu trebuie sa fie mare de 20 cm.

Livrare				
Dimensiuni [mm]	5x20	10x20	15x20	20x25
Lungime livrare [m]	25	10	5	5
Cantitate minima [m]	100	100	100	100



Produse speciale pentru Constructii

HIDROPLASTO

WWW.HIDROPLASTO.RO

Injectia cu rasini

Tubul de injectie Besaplast®- 6/12 WP se foloseste pentru etansarea rosturilor de constructie si aditional, in etansarea secundara in combinatie cu profilele de

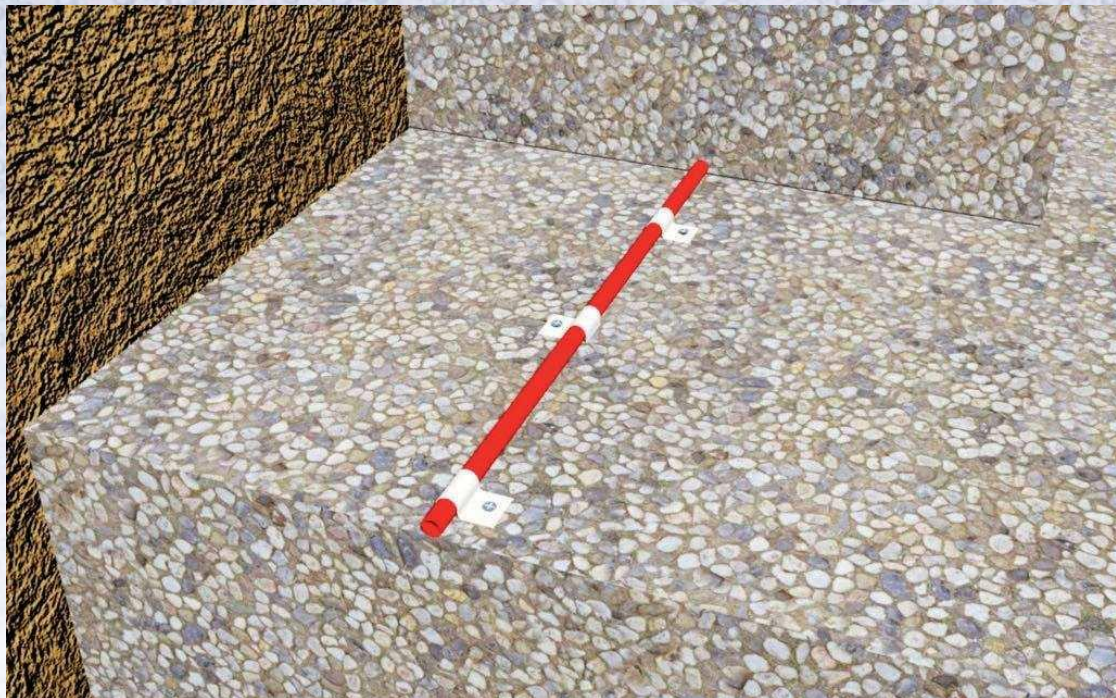



Produse speciale pentru Constructii

HIDROPLASTO

WWW.HIDROPLASTO.RO

Injectia cu rasini

profil perete unic

Grad elasticitate ridicat

inofensiv pentru apa potabila

posibilitatea multiplelor injectari

functioneaza cu toate tipurile de mortar folosit

pentru injectare

cu presiune pana la 13 bari (188 PSI)

lungimea recomandata pentru tubul de injectie:

in functie de injectarea mortarului, max.cca.10 m

se curata prin aer comprimat sau apa (in functie de mortarul injectat)

rezistenta la produse chimice ridicata

Testare certificata

lungime livrare: role de 100 m





Profile / benzi etansare speciale

Tip	a	c
S 60	60	4
S 80	80	4
S 100	100	4
S 120	120	4

Besaflex® conform Standard companie

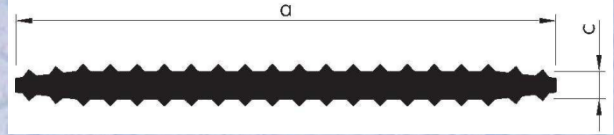

Tip	a	c
S 60 PE	60	4
S 80 PE	80	4
S 100 PE	100	4
S 120 PE	120	4

Polyflex® conform Standard companie

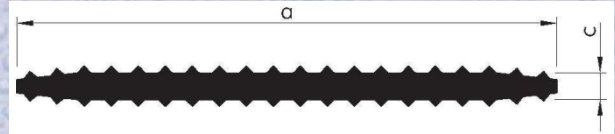

Tip	a	c
S 80 L	80	12
S 120 L	120	12

Besaflex conform Standard companie

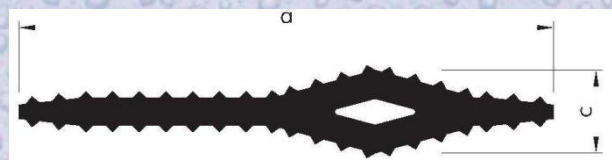

Tip	a	c
RF 80	80	0,8
RF 115	115	0,8
RF 175	175	0,8
RF 240	240	0,8
RF 365	365	0,8
RF 550	550	1,2
RF 700	700	1,2

Besaflex conform Standard companie

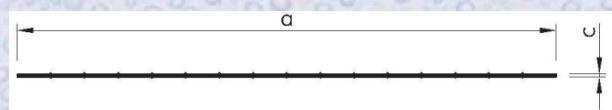

Tip	a	c
S 60	60	4
S 80	80	4
S 100	100	4
S 120	120	4

Besaflex conform Standard companie

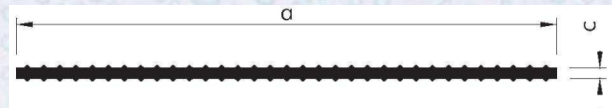



Profile / benzi etansare speciale

BOD 200 i
Nitriflex® conform DIN 18541 Parte 2

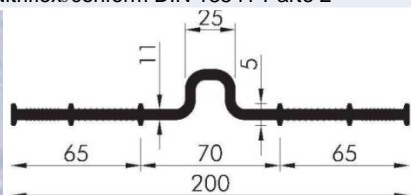

BOD 240 i
Nitriflex® conform DIN 18541
Parte 2

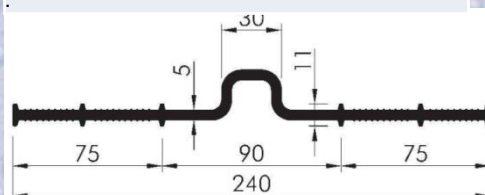

DON 500
Nitriflex conform DIN 18541 Parte 2

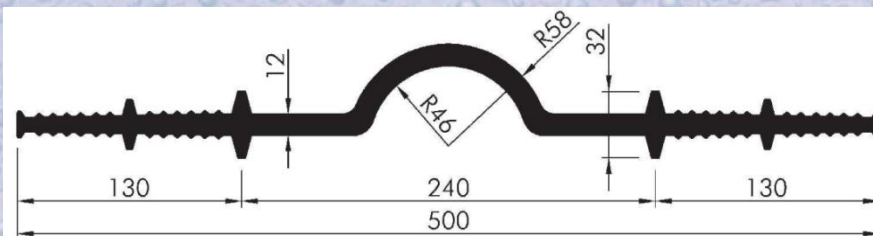

BOD 200 i
Nitriflex® conform DIN 18541 Parte 2

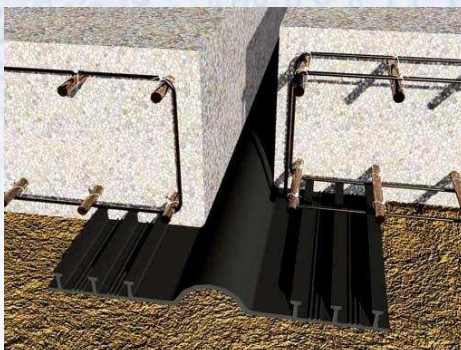
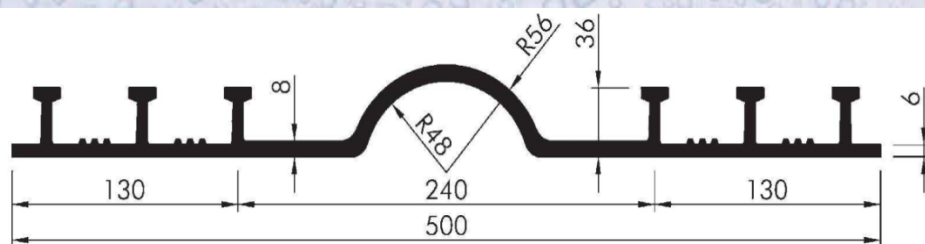



Profile / benzi etansare speciale

AA 650/323

Nitriflex® conform DIN 18541 Parte 2

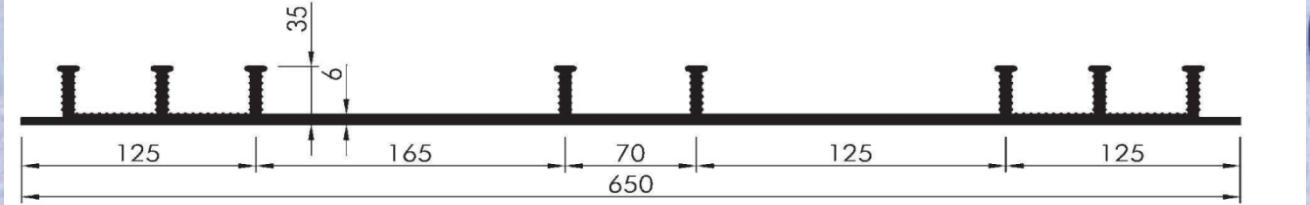

AA 650/323

Nitriflex® conform DIN 18541 Parte 2

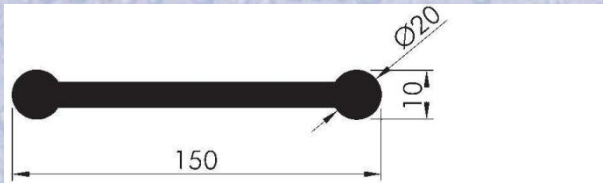

DCL 150/10

Nitriflex® conform DIN 18541 Parte 2

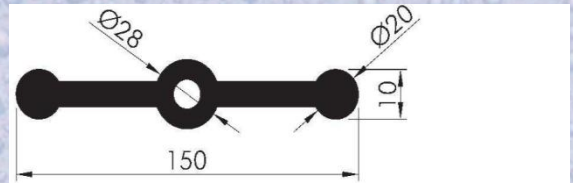

ACL 230/10

Nitriflex® conform DIN 18541 Parte 2

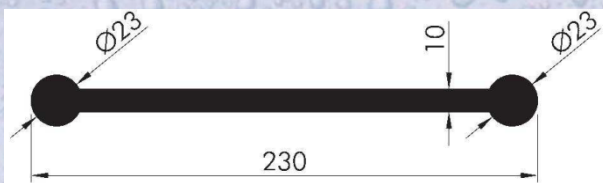

DCL 230/10

Nitriflex® conform DIN 18541 Parte 2

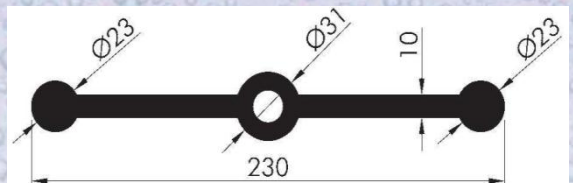

A 320 Injekt

Nitriflex® conform DIN 18541 Parte 2

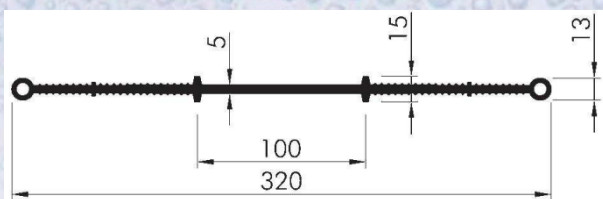

D 320 Injekt

Nitriflex® conform DIN 18541 Parte 2

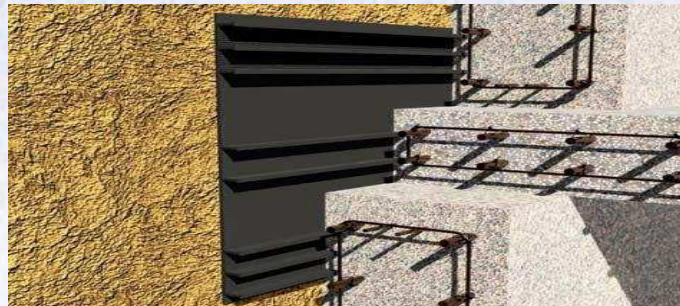
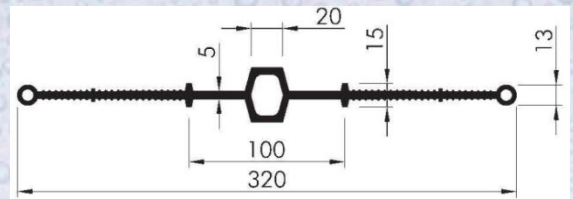



Produse speciale pentru Constructii

HIDROPLASTO

WWW.HIDROPLASTO.RO

Profile / benzi etansare cu ancora tip T

Cuzinetii in forma de T Hidroplasto®-T-sunt foi de etansare din plastic omogen si extrudat din PVC (clorura de polivinil)sau HDPE (polietilena de mare densitate) care, datorita compozitiei sale, ofera o rezistenta extrem de ridicata la solutiile chimice agresive. Datorita procesului de extruziune, produsul formeaza o unitate completa.

Doar materialele special selectate se folosesc in aceasta etansare si sistem de protectie.





Profile / benzi etansare cu ancora tip T

Forma speciala a cuzinetilor este determinate de ancore in forma de T, integrate si rigide, perfecte pentru fixarea in beton, oferind astfel imbinarea conventionala necesara.

Scurgerile cauzate de daunele de dupa instalare pot fi localizate mai repede decat in straturile de etansare ne- profilate. Acorele in forma de T continue limiteaza zona unde se gasesc scurgeri si care trebuie reparata. Este un alt produs ce ofera posibilitatea reparatiilor cu cheltuieli minore.

Aplicarile cuzinetilor in forma de T sunt variate si adaptate permanent la noi cereri. Certificarile testelor eliberate de MPA (Institutul de Testare a Materialelor North-Rhine-Westphalia) confirmaproprietatile exceptionale ale materialelor folosite. Foile subtiri sub forma de plasa nu doar asigura o etansare perfecta dar si protejeaza betonul de influentele chimice si barele de otel de coroziune. Structura de beton trebuie protejata de substantele agresive cum ar fi acidul sulfuric, sarurile ofensive, componenti organici, grasimi, acizi, etc. Cuzinetii in forma de T pot fi livrati sub forma de diferite lungime si grosimi. Besaplast Kunststoffe GmbH produce de asemenea si controleaza productia de profiluri speciale, de la fabricarea uneltelor la extruziune





Profile / benzi etansare cu ancora tip T



ST 1,6 ST 16 PE
Grosime: 1,6 mm

ST 2,0 ST 20 PE
Grosime: 2,0 mm

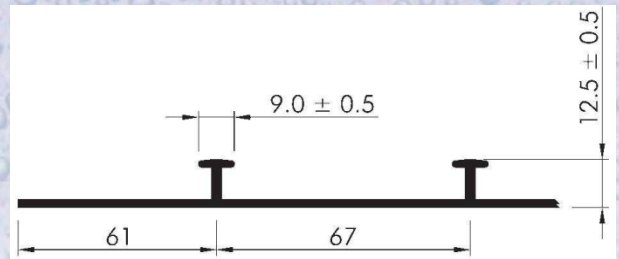
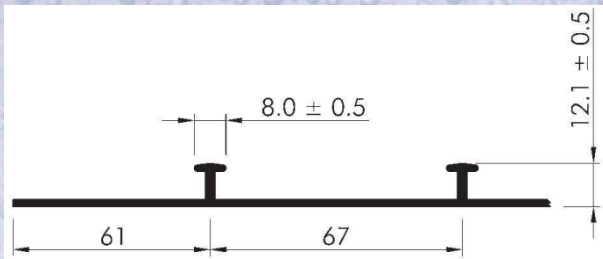

ST 2,5 ST 25 PE
Grosime: 2,5 mm

ST 3,0 ST 30 PE
Grosime: 3,0 mm

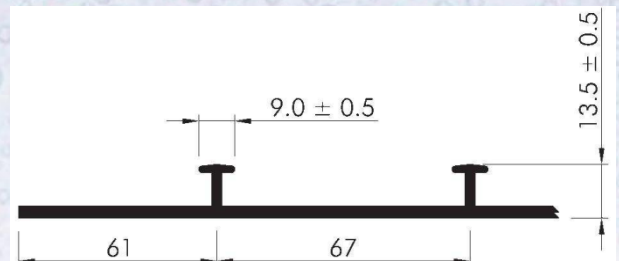
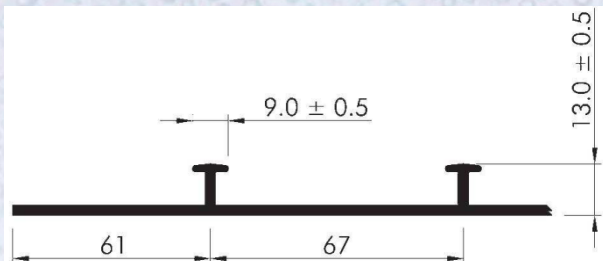



Produse speciale pentru Constructii

HIDROPLASTO

WWW.HIDROPLASTO.RO

Piese de intersectare

Forma 1 placa-X

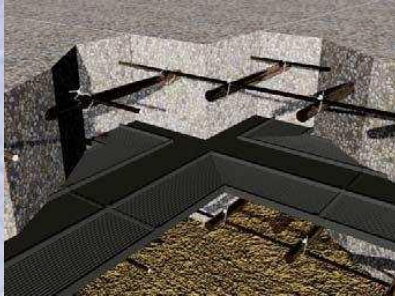

Forma 2 placa-T

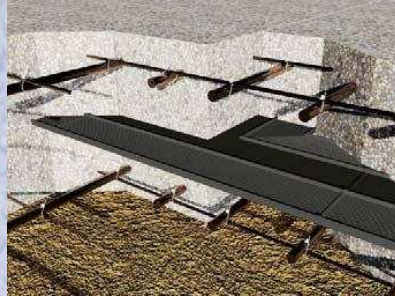

Forma 3 placa-L

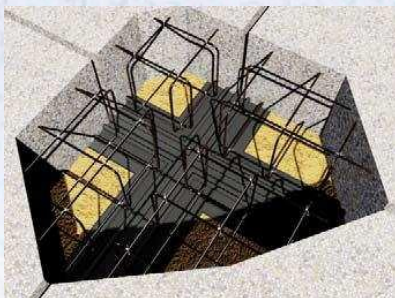
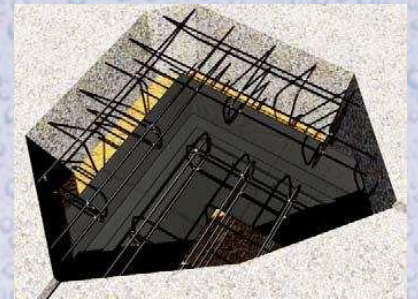
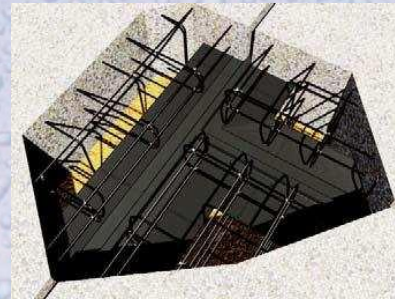
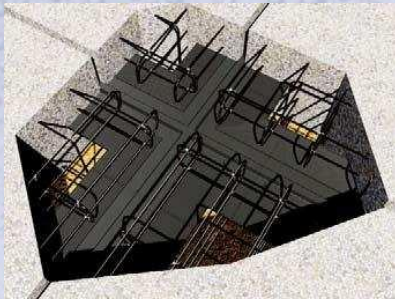
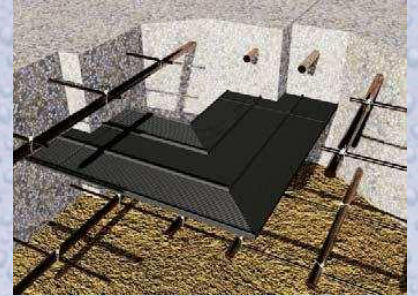



Produse speciale pentru Constructii

HIDROPLASTO

WWW.HIDROPLASTO.RO

Piese de intersectare

Forma 4 vertical-X



Forma 5 vertical-T



Forma 6 vertical-L

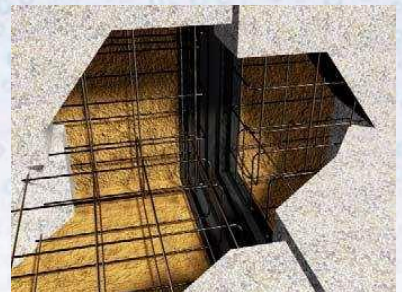
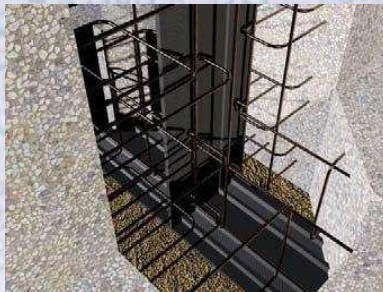
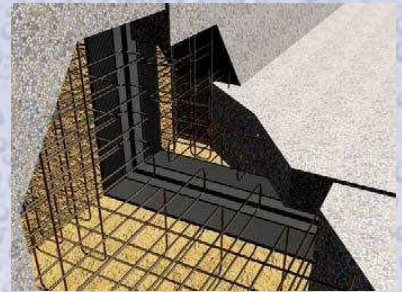
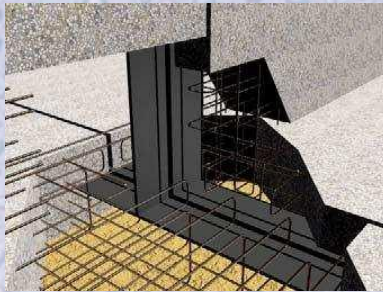
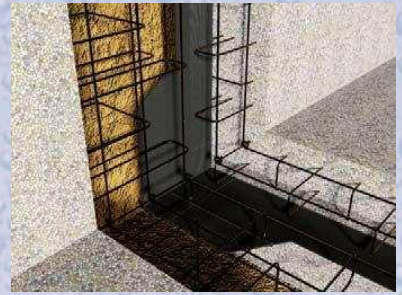



Produse speciale pentru Constructii

HIDROPLASTO

WWW.HIDROPLASTO.RO

Piese de intersectare

Piese speciale de intersectare

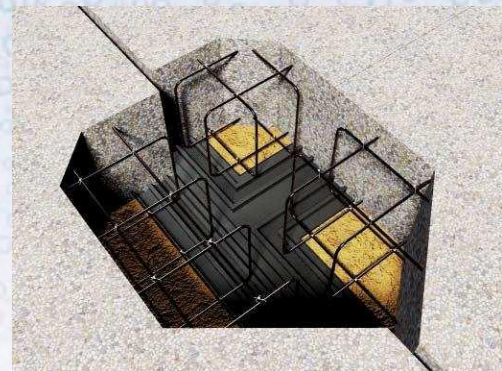
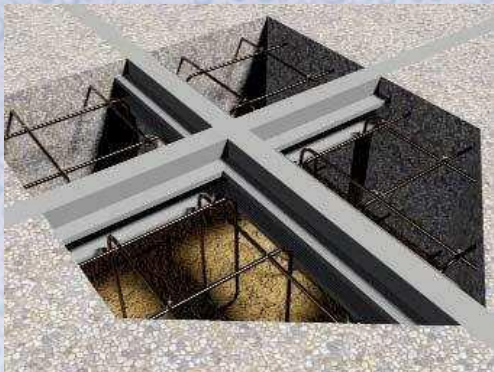



Produse speciale pentru Constructii

HIDROPLASTO

WWW.HIDROPLASTO.RO

Accesorii pentru montaj

Dispozitiv de sudura cu lama subtire de 125w, 200w, 300w



Sistem de sudura cu precizie ridicata format din bacuri speciale de prindere si presare a profilului



Suflanta aer cald





Produse speciale pentru Constructii

HIDROPLASTO

WWW.HIDROPLASTO.RO

Accesorii pentru sudura

Aparat sudare
compartiment livrare:

- cutie transport
- aparat sudare
- matrita pentru pene de etansare
- distantator
- burete pentru curatat
- manual instructiuni



Aparat vulcanizare
compartiment disponibil pentru livrare:

- cutie transport
- aparat vulcanizare
- matrita pentru pene de etansare
- cutit
- polizor
- compresor
- cheie fixa
- solvent vulcanizare
- benzi de cauciuc
- snur/ fir vulcanizare

Benzi de cauciuc

Marimi disponibile:

- 30 x 1,0 mm
- 30 x 1,5 mm
- 50 x 1,0 mm
- 50 x 1,5 mm
- 50 x 3,0 mm
- 80 x 3,0 mm
- 80 x 4,0 mm
- 100 x 4,0 mm





Produse speciale pentru Constructii

HIDROPLASTO

WWW.HIDROPLASTO.RO

Accesorii cofraj

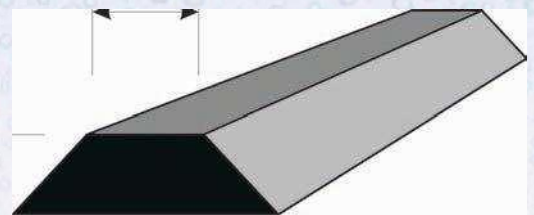
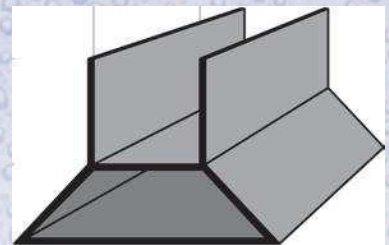
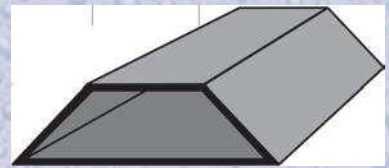



Produse speciale pentru Constructii

HIDROPLASTO

WWW.HIDROPLASTO.RO

Accesorii cofraj

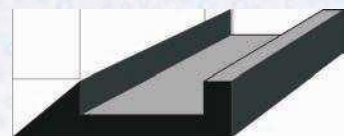
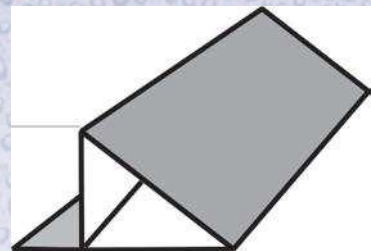
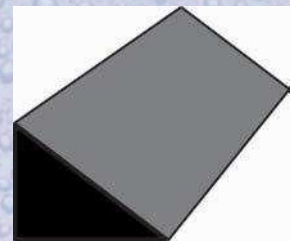
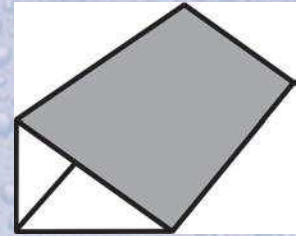



Produse speciale pentru Constructii

HIDROPLASTO

WWW.HIDROPLASTO.RO

Accesorii cofraj

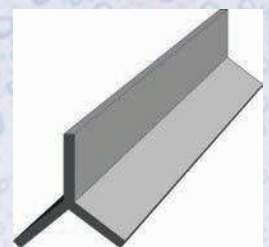
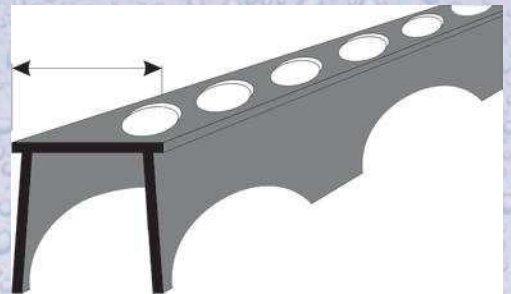
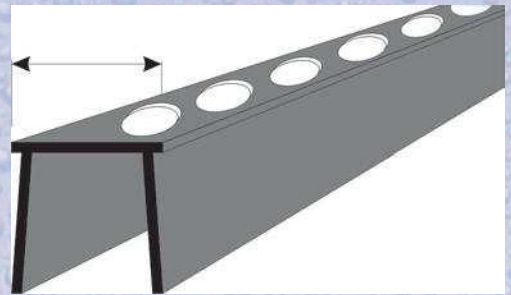



Accesorii cofraj

Rondelle

Ø 90 mm

Disponibil in PVC si PE.

.

®

Distantator- scoaba

Distantator pentru armatura in proiecte de tunel.

Disponibil in PVC si PE.

Scoaba de deschidere pentru bara de otel- Ø 8 - 10 mm





Instructiuni pentru sudura

Pregatire

Capetele profilelor de etansare trebuie sa fie pre-incalzite, daca sunt folosite in medii reci (temperatura sub +5°C/+41° F). Temperatura materialului capetelor profilelor de etansare trebuie sa fie mai mare de +15°C/59° F. Profilele de etansare trebuie sa fie curate si uscate. Pentru fabricarea racordului cap la cap, capetele trebuie sa fie taiate drept pe lungimea profilului de etansare (folositi corniera fixatoare si un cutit ascutit). Calitatea taierii este foarte importanta pentru calitatea sudarii. Reparatiile si corectarile necesita unelte speciale si material pentru sudare.

Temperatura de sudare

Temperatura de sudare depinde in principal de materialul profilului de etansare si de temperatura din exterior. Prin urmare, valorile de mai jos pot fi doar orientative. Pentru a determina temperatura corecta pentru dispozitivele de sudare, testele trebuie facute inainte de sudarea actuala.

ATENTIE: Temperatura maxima 215 °C/ 419° F

Besaflex:

Nitriflex:

Polyflex:

TPE:

180 - 190 °C/ 356 - 374° F

160 - 170 °C/ 320 - 338° F

215 °C/ 419° F

150 - 210 °C/ 302 - 410° F

Pregatirea

Modelele de pene de etansare trebuie fabricate inainte de procesul de sudare actual pentru a evalua comportamentul sudarii penelor de etansare si de a stabili parametrii corecti de sudare adaptate conditiilor date.

Tineti dispozitivul de placa de deasupra si scoateti-o din cutia de transport.

Clemele incluse trebuie montate in partea de sus a placii dispozitivului folosind suruburile clemei.





Instructiuni pentru sudura

Dispozitivul trebuie sa fie conectat la o sursa de alimentare electrica. Asigurati-va ca voltajul si curentul sursei de alimentare sa fie conform valorilor mentionate pe placuta cu mentiuni de pe dispozitiv. Doar daca aceste valori se potrivesc, porniti dispozitivul prin rasucirea butonului de deschidere in pozitia I. Elementele radiatorului vor incepe sa incalzeasca dispozitivul pana la o temperatura de sudare maxima de 215°C/ 419° F .

Intre timp, lampa de control portocalie se va aprinde.

Daca dispozitivul atinge temperatura de sudare programata, lampa de control se va inchide. Dispozitivul este acum pregatit pentru sudare. Sudarile nu pot fi efectuate pana nu se ajunge in acest punct.

Elementul de incalzire se foloseste prin miscarea manerului de plastic pana la capat. Placuta de deasupra poate fi ajustata prin levierul de compresie. Miscand levierul de compresie, placuta de deasupra este blocata in pozitia sa.

La inceputul procesului de sudare, dispozitivul va fi in urmatoarea pozitie de pornire:

- dispozitiv pre- incalzit
- partea de baza a clemei fixate pe placuta de deasupra (cand se lucreaza cu pene de etansare interne sau rosturi de acoperire)
- partea de deasupra a clemei dinauntru compartimentului
- placuta de deasupra in pozitia de deschidere
- elemente de incalzire curatate (doar cu laveta!)





Instructiuni pentru sudura

Suspendarea si spatierea profiluri de pene de etansare

Asezati distantatorul in fanta de deschidere a placutei de deasupra pentru a ajusta cele doua capete ale profilului de etansare. Mutati unul din cele doua capete ale profilului de etansare catre fiecare parte a distantatorului pana ce intreaga zona unde au fost taiate profilele de etansare atinge ambele capete ale profilului de etansare. Dupa aceasta, partile de deasupra clemelor sunt instalate in ambele capete ale profilului de etansare. Fixati-le folosind suruburi de prindere.

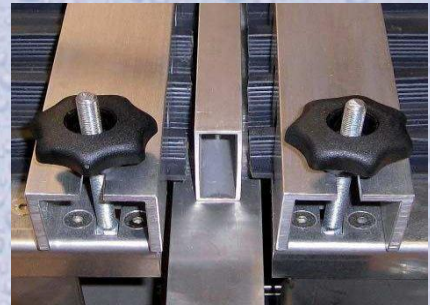

Incalzirea

Apasati cu presiune egala unei greutatei de 1- 3 kg. pe levierul de compresiune. Mentineti cca 10-20 secunde. In aceasta perioada, va aparea o proeminenta de la sudura de cca. 1 mm inaltime, consolidand capetele profilului de etansare.



Cuplare

Consola de sudura va fi indepartata, rosturile fasiei dau drumul capetelor de la elementul de incalzire iar elementul de incalzire trebuie asezat jos. Stantarea nu trebuie sa depaseasca 2 secunde.





Instructiuni pentru sudura

Trebuie sa se ataseze protectia de lemn in stare racita. Dupa incetinirea lamei radiatorului, masina se afla in pozitia de baza.

®

Verificare

Dupa racirea completa a conexiunii sudate, poate fi montata, insa nu inainte de examinarea.

Trebuie sa fie respectate cerintele DIV V 18197.

Testare:

- test vizual
- test indoire
- test scantei frecventa inalta
→ eroare afisaj patrundere scantei.

Din cauza sudurii este posibila aparitia unei proeminente.

Se va indeparta inainte de testare.

Finisari posibile

Defectele mici se pot suda manual (dispozitiv aer cald)

sau se poate adauga un cablu rotund (piston conic, dispozitiv aer cald) pentru a realiza finisarile.

Altfel, sudura va trebui taiata si reinnoita structura.





PROFILE / BENZI ETANSARE EXTERNE PENTRU ROSTURI DE TURNATE

Imbinare

Pentru imbinare, compartimentele de sudare trebuie presate impreuna timp de 2 secunde. Presiunea trebuie sa fie echivalentul a 3 pana la 12 kg (in functie de tipul profilului de etansare).

Dupa aceasta, compartimentul de sudura trebuie blocat intorcand/apasand levierul de presiune. Se va mentine presiunea asupra imbinarii in mod constant

Racirea

Trebuie lasat in pozitie cca 5 minute. Trebuie mentinuta presiunea in timpul racirii imbinarii.

Instructiuni pentru sudare Curent de aer

Dupa racire, sinele de fixare sunt rezolvate.

Conexiunea poate fi acum detasata de compartimentul de sudare si depozitat in lateral. Dupa o perioada de 10 minute, conexiunea poate fi schimbata. Curatarea Se va rezolva fixarea levierului de presiune iar compartimentul de sudare trebuie indepartat. Lama radiatorului este integrata. Lama radiatorului trebuie curatata dupa fiecare sudura.

ATENTIE: invelisul elementelor radiatorului pot fi avariate daca se folosesc unelte!

ATENTIE: Lama radiatorului este fierbinte! Se va evita pe cat posibil contactul direct, folosind manusi rezistente la caldura.





PROFILE /BENZI ETANSARE EXTERNE PENTRU ROSTURI DE TURNATE

Profilele de etansare elastomeri un pot fi imbinat prin metode traditionale de sudare, ci mai degraba prin vulcanizare. Aceasta procedura necesita si imbinarea cauciucului brut prin presiune si caldura. Singurul tip de vulcanizare efectuat in santierele de constructie este vulcanizarea imbinarilor de baza ce pot fi executate de orice muncitor in constructii dupa instruirea corespunzatoare.

Pasul 1

Echipamentul de vulcanizare si matritele de aluminiu sunt preincalzite pt cca 30 min. Matritele trebuie sa ajunga la temperatura de cca. 160 °C. In timpul ciclului de preincalzire, profilele de etansare pot fi pregatite.

Pasul 2

Cele doua capete ale profilului de etansare ce vor fi imbinat trebuie taiate exact la 90° cu un cutit ascutit. Prin urmare, cele doua capete dreptunghiulare ale profilului de etansare sunt fixate cu un dispozitiv de lemn suspendat, iar profilele de etansare vor iesi de fiecare parte cca. 10 cm in colier/ clema.

Pasul 3

Capete iesite si capetele din fata ale profilului de etansare ce vor fi imbinat sunt prelucrate peste tot uniform si in intregime cu o roata de slefuire (roata poate fi folosita intr-un burghiu/ perforator electric).

Pasul 4

Indepartati praful de la slefuire de pe suprafetele profilului de etansare si aplicati apoi un strat subtire de solutie de incalzire ce trebuie lasata sa se usuce cca. 5 minute. Suprafetele acoperite trebuie pastrate curate si sa nu fie atinse.

Pasul 5

Pentru profilele de etansare rosturi de trecere, tubul central este inchis cu un dop de cauciuc inserat cca 5-6 cm inaintul tubului pana ce dopul este egal cu capatul din fata. Acest dop este foarte important pentru vulcanizarea penelor de etansare pentru rosturi de trecere, intrucat presiunea ridicata a tiparului vulcanizat langa tubul central va fi insuficienta datorita partii scobite din profilul de etansare.



Instructiuni pentru vulcanizare

Pasul 6

Capetele din fata ale profilului de etansare sunt acoperite cu un strat subtire de cauciuc brut adeziv iar lungimile iesite sunt indoite inapoi. Asigurati-va ca stratul adeziv sa fie presat intocmai contra partii din fata. Filmul de protectie este apoi desprins.

Pasul 7

Cele doua cleme de lemn sunt presate impreuna cu suruburi lungi pana ce capetele din fata ale profilului de etansare sunt in contact perfect. Capetele pre-incalzite din fata adereaza imediat una spre cealalta.

Pasul 8

Acum , un strat de 50x3 mm de banda de cauciuc brut inveleste de jur imprejur rostul dupa indepartarea filmului de protectie. Apoi, un al doilea strat de 80x30 mm de banda de cauciuc brut este asezat peste rost. Grosimea bandajului de cauciuc brut trebuie sa fie de cel putin 6 mm.

Pasul 9

Amplasati imbinarea pregatita a profilului de etansare in unitatea preincalzita de vulcanizare si inchideti. Strangeti suruburile clemei pana ce jumatatile tiparului de aluminiu se afla in contact ferm. In mod normal, tiparul inca nu trebuie inchis complet daca bandajul de cauciuc brut are grosimea corecta. Asteptati cca 5-10 min inainte de a mai strange o data suruburile clemei. In functie de conditiile climei *) si a temperaturilor de afara, cauciucul brut este vulcanizat in intregime dupa 25-30 minute iar unitatea de vulcanizare poate fi din nou deschisa.

*) Daca vantul este puternic iar temperaturile de afara sunt scazute, unitatea trebuie acoperita cu folii sau tablii de cofraj.



Instructiuni pentru vulcanizare

Pasul 10

Imbinarea vulcanizata trebuie tratata cu atentie pana la rezistenta completa a rostului, obtinuta doar dupa racire. Daca suprafata este in continuare susceptibila la deformatiile de plastic (se testeaza cu unghia sau cu o surubelnita), procesul de vulcanizare nu este in intregime terminat. Aceasta problema apare cand nu se ating temperaturi de 160°C sau cand ciclul de vulcanizare este prea scurt. Plasati o banda de ajustare de cauciuc brut pentru a repara denivelarile zonei imbinate. Unitatea de vulcanizare poate fi inchisa din nou iar reincalzirea se va face dupa 10 minute.

Daca suprafata benzii de cauciuc este poroasa si nu arata bine, bandajul cauciucului brut de pe imbinare nu este destul de gros astfel ca presiunea nu poate intra in interiorul cauciucului.

Vulcanizarea la rece

1. Aspriti suprafata de imbinare a profilului de etansare folosind o perie de sarma si indepartati praful produs.
2. Aplicati repede adezivul pe capetele din fata ale profilului de etansare si apasati capetele unul spre celalalt.
3. Aplicati ciment special BL in cantitate generoasa pe zona de imbinare si lasati sa se usuce (la 20 °C, cca. 10 – 30 Minute)
4. Amestecati compozitia rece de vulcanizare A si B in parti de 1:1 si framantati cu putere pana ce au disparut benzile deschise la culoare (cca. 5 – 10 Minute, manual)
5. Aplicati amestecul de componente A+B in cantitate generoasa straturi subtiri si fara goluri de aer pe zona ce trebuie reparata si apasati pe suprafata.
Lasati imbinarea cca. 8 ore.